

# fire safety risk assessment

factories and warehouses

**Copyright in the contents, the cover, the design and the typographical arrangement rests with the Crown. This document/publication is value added. If you wish to re-use this material, please apply for a Click-Use Licence for value added material at [www.opsi.gov.uk/click-use/system/online/pLogin.asp](http://www.opsi.gov.uk/click-use/system/online/pLogin.asp)**

Alternatively applications can be sent to:

OPSI, Information Policy Team, St Clements House, 2-16 Colegate, Norwich NR3 1BQ

Fax: 01603 723000

E-mail: [HMSOLicensing@cabinet-office.x.gsi.gov.uk](mailto:HMSOLicensing@cabinet-office.x.gsi.gov.uk)

This publication has been approved by Ministers and has official status. The contents of this publication may be reproduced free of charge in any format or medium for the purposes of private research and study or for internal circulation within an organisation. This is subject to the contents being reproduced accurately and not in a way that implies official status. Any publisher wishing to reproduce the content of this publication must not use or replicate the HMG logo or replicate the official version's style and appearance, including the design, and must not present their publication as being an official publication as this may confuse the public. The reproduced material must be acknowledged as Crown Copyright and the title of the publication specified. HM Government does not accept any responsibility for the accuracy and the comprehensiveness of any other versions.

Any other use of the contents of this publication would require a copyright licence. Further information can be obtained from [www.opsi.gov.uk](http://www.opsi.gov.uk)

Department for Communities and Local Government Publications  
PO Box 236  
Wetherby  
West Yorkshire  
LS23 7NB  
Tel: 0870 830 7099  
Fax: 0870 1226 237  
Textphone: 0870 1207 405  
E-mail: [odpm@twoten.press.net](mailto:odpm@twoten.press.net)

This document is also available on the DCLG website: [www.firesafetyguides.communities.gov.uk](http://www.firesafetyguides.communities.gov.uk)

Reference number: 05 FRSD 03338 (b)

Published by the Department for Communities and Local Government, Eland House, Bressenden Place  
London SW1E 5DU, May 2006.

© Crown Copyright 2006.

Printed on material containing 100% post-consumer waste (text), 75% post-consumer waste and 25% ECF pulp (cover).

ISBN-13: 978 1 85112 816 7

ISBN-10: 1 85112 816 6

# Contents

<b>How to use this guide</b>	2
<b>Preface</b>	3
<b>Introduction</b>	4
<b>Part 1 Fire risk assessment</b>	9
<b>Step 1</b> Identify fire hazards	12
<b>Step 2</b> Identify people at risk	14
<b>Step 3</b> Evaluate, remove, reduce and protect from risk	15
<b>Step 4</b> Record, plan, inform, instruct and train	33
<b>Step 5</b> Review	38
<b>Part 2 Further guidance on fire risk assessment and fire precautions</b>	41
<b>Section 1</b> Further guidance on fire risks and preventative measures	42
<b>Section 2</b> Further guidance on fire detection and warning systems	55
<b>Section 3</b> Further guidance on firefighting equipment and facilities	59
<b>Section 4</b> Further guidance on escape routes	66
<b>Section 5</b> Further guidance on emergency escape lighting	104
<b>Section 6</b> Further guidance on signs and notices	107
<b>Section 7</b> Further guidance on recording, planning, informing, instructing and training	110
<b>Section 8</b> Quality assurance of fire protection equipment and installation	118
<b>Appendix A</b> Example fire safety maintenance checklist	119
<b>Appendix B</b> Technical information on fire-resisting separation, fire doors and door fastenings	123
<b>Appendix C</b> Historic buildings	130
<b>Appendix D</b> Glossary	132
<b>References</b>	137
<b>Further reading</b>	140
<b>Index</b>	143

# How to use this guide

This guide is divided into two parts:

- **Part 1** Explains what fire risk assessment is and how you might go about it. Fire risk assessment should be the foundation for all the fire precautions in your premises.
- **Part 2** Provides further guidance on fire precautions. The information is provided for you and others to dip into during your fire risk assessment or when you are reviewing your precautions.

The appendices provide example checklists, some detailed technical information on fire-resisting elements and advice on historic buildings.

This guide is one from a series of guides listed on the back cover.

The rest of this introduction explains how the law applies.

Technical terms are explained in the glossary and references to other publications listed at the end of this book are identified by a superscript number in the text.

In this guide reference is made to British Standards and standards provided by other bodies. The standards referred to are intended for guidance only and other standards could be used. Reference to any particular standard is not intended to confer a presumption of conformity with the requirements of the Regulatory Reform (Fire Safety) Order 2005 (the Order).<sup>1</sup>

The level of necessary safety (or service) must be dictated by the findings of your risk assessment so you may need to do more or less than that specified in any particular standard referred to. You must be prepared to show that what you have done complies with any requirements or prohibitions of the Order<sup>1</sup> irrespective of whether you have relied on a particular standard.

A full list of references, e.g.<sup>1</sup>, can be found at the back of this book.

# Preface

This guidance gives advice on how to avoid fires and how to ensure people's safety if a fire does start. Why should you read it? Because:

- Fire kills. In 2004 (England and Wales) fire and rescue services attended over 33,400 fires in non-domestic buildings. These fires killed 38 people and injured over 1,300.
- Fire costs money. The costs of a serious fire can be high and afterwards many businesses do not reopen. In 2004, the costs as a consequence of fire, including property damage, human casualties and lost business, were estimated at £2.5 billion.

This guide applies to England and Wales only. It does not set prescriptive standards, but provides recommendations and guidance for use when assessing the adequacy of fire precautions in factories and warehouses. Other fire risk assessment methods may be equally valid to comply with fire safety law. The guide also provides recommendations for the fire safety management of the premises.

Your existing fire safety arrangements may not be the same as the recommendations used in this guide but, as long as you can demonstrate that they meet an equivalent standard of fire safety, they are likely to be acceptable. If you decide that your existing arrangements are not satisfactory there may be other ways to comply with fire safety law. This means there is no obligation to adopt any particular solution in this guide if you prefer to meet the relevant requirement in some other way.

Where the building has been recently constructed or significantly altered, the fire detection and warning arrangements, escape routes and facilities for the fire and rescue service should have been designed, constructed and installed in accordance with current building regulations. In such cases, it is likely that these measures will be satisfactory as long as they are being properly maintained and no significant increase in risk has been introduced.

In addition, earlier legislation, including local authority acts may have imposed additional requirements for fire precautions for large storage buildings where more than 7,000m<sup>3</sup> is used for storing or depositing goods or materials (e.g. access, compartmentation, monitored automatic fire detection and/or smoke control and/or sprinklers to be maintained).

This guide should not be used to design fire safety in new buildings. Where alterations are proposed to existing factories and warehouses, they may be subject to building regulations. However, it can be used to develop the fire safety strategy for the building.

# Introduction

## **WHO SHOULD USE THIS GUIDE?**

This guide is for all employers, managers, occupiers and owners of factories and warehouses. Details of other guides in the series are listed on the back cover. It tells you what you have to do to comply with fire safety law, helps you to carry out a fire risk assessment and identify the general fire precautions you need to have in place.

This guide is intended for premises where the main use of the building or part of the building is a factory or warehouse. It may also be suitable where the premises adjoin other complexes, although co-operation with other managers will be necessary as part of an integrated risk assessment for the complex.

Also, where you handle and store flammable materials and substances, it will help you take account of these in your risk assessment and help you determine the necessary precautions to take to minimise the likelihood of them being involved in a fire.

It has been written to provide guidance for a responsible person, to help them to carry out a fire risk assessment in less complex factories and warehouses. If you read the guide and decide that you are unable to apply the guidance, then you should seek expert advice of a competent person. More complex premises will probably need to be assessed by a person who has comprehensive training or experience in fire risk assessment. However this guide can be used for multi-occupied buildings to address fire safety issues within their individual occupancies.

It may also be useful for:

- employees;
- employee-elected representatives;
- trade union-appointed health and safety representatives;
- enforcing authorities; and
- all other people who have a role in ensuring fire safety in factories and warehouses.

If your premises are listed as of historic interest, also see Appendix C.

Fire safety is just one of many safety issues management must address to minimise the risk of injury or death to staff or the public. Unlike most of the other safety concerns, fire has the potential to injure or kill large numbers of people very quickly. This guidance is concerned only with fire safety, but many of the measures discussed here will impact upon other safety issues, and vice versa. It is recognised that these differing safety demands can sometimes affect one another and management should consult other interested agencies, such as the Health and Safety Executive (HSE), where necessary to confirm that they are not contravening other legislation/guidance.

You can get advice about minimising fire losses from your insurer.

## **THE FIRE SAFETY ORDER**

### **Previous general fire safety legislation**

The Order<sup>1</sup> replaces previous fire safety legislation. Any fire certificate issued under the Fire Precautions Act 1971<sup>2</sup> will cease to have any effect. If a fire certificate has been issued in respect of your premises or if the premises were built to recent building regulations, as long as you have made no material alterations and all the physical fire precautions have been properly maintained, then it is unlikely you will need to make any significant improvements to your existing physical fire protection arrangements to comply with the Order.<sup>1</sup> However, you must still carry out a fire risk assessment and keep it up to date to ensure that all the fire precautions in your premises remain current and adequate.

If you have previously carried out a fire risk assessment under the Fire Precautions (Workplace) Regulations 1997,<sup>3</sup> as amended 1999,<sup>4</sup> and this assessment has been regularly reviewed, then all you will need to do is revise that assessment taking account of the wider scope of the Order<sup>1</sup> as described in this guide.

Your premises may also be subject to the provisions of a licence or registration (e.g. under the Licensing Act 2003), and the fire authority may wish to review your risk assessment as part of the licensing approval process. Fire safety conditions within your premises licence should not be set by a licensing authority where the Order applies.

### **Background**

The Order<sup>1</sup> applies in England and Wales. It covers general fire precautions and other fire safety duties which are needed to protect 'relevant persons' in case of fire in and around most 'premises'. The Order<sup>1</sup> requires fire precautions to be put in place 'where necessary' and to the extent that it is reasonable and practicable in the circumstances of the case.

Responsibility for complying with the Order<sup>1</sup> rests with the 'responsible person'. In a workplace, this is the employer and any other person who may have control of any part of the premises, e.g. the occupier or owner. In all other premises the person or people in control of the premises will be responsible. If there is more than one responsible person in any type of premises (e.g. a multi-occupied complex), all must take all reasonable steps to co-operate and co-ordinate with each other.

If you are the responsible person you must carry out a fire risk assessment which must focus on the safety in case of fire of all 'relevant persons'. It should pay particular attention to those at special risk, such as disabled people, those who you know have special needs and young persons, and must include consideration of any dangerous substance liable to be on the premises. Your fire risk assessment will help you identify risks that can be removed or reduced and to decide the nature and extent of the general fire precautions you need to take.

If your organisation employs five or more people, your premises are licensed or an alterations notice is in force, you must record the significant findings of the assessment. It is good practice to record your significant findings in any case.

There are some other fire safety duties you need to comply with:

- **You must** appoint one or more competent persons, depending on the size and use of your premises, to carry out any of the preventive and protective measures required by the Order<sup>1</sup> (you can nominate yourself for this purpose). A competent person is someone with enough training and experience or knowledge and other qualities to be able to implement these measures properly.
- **You must** provide your employees with clear and relevant information on the risks to them identified by the fire risk assessment, about the measures you have taken to prevent fires, and how these measures will protect them if a fire breaks out.
- **You must** consult your employees (or their elected representatives) about nominating people to carry out particular roles in connection with fire safety and about proposals for improving the fire precautions.
- **You must**, before you employ a child, provide a parent with clear and relevant information on the risks to that child identified by the risk assessment, the measures you have put in place to prevent/protect them from fire and inform any other responsible person of any risks to that child arising from their undertaking.
- **You must** inform non-employees, such as temporary or contract workers, of the relevant risks to them, and provide them with information about who are the nominated competent persons, and about the fire safety procedures for the premises.
- **You must** co-operate and co-ordinate with other responsible persons who also have premises in the building, inform them of any significant risks you find, and how you will seek to reduce/control those risks which might affect the safety of their employees.
- **You must** provide the employer of any person from an outside organisation who is working in your premises (e.g. an agency providing temporary staff) with clear and relevant information on the risks to those employees and the preventive and protective measures taken. You must also provide those employees with appropriate instructions and relevant information about the risks to them.
- If you are not the employer but have any control of premises which contain more than one workplace, **you are also responsible** for ensuring that the requirements of the Order<sup>1</sup> are complied with in those parts over which you have control.
- **You must** consider the presence of any dangerous substances and the risk this presents to relevant persons from fire.
- **You must** establish a suitable means of contacting the emergency services and provide them with any relevant information about dangerous substances.
- **You must** provide appropriate information, instruction and training to your employees, during their normal working hours, about the fire precautions in your workplace, when they start working for you, and from time to time throughout the period they work for you.



- **You must** ensure that the premises and any equipment provided in connection with firefighting, fire detection and warning, or emergency routes and exits are covered by a suitable system of maintenance, and are maintained by a competent person in an efficient state, in efficient working order and in good repair.
- **Your employees must** co-operate with you to ensure the workplace is safe from fire and its effects, and must not do anything that will place themselves or other people at risk.

The above outline some of the main requirements of the Order.<sup>1</sup> The rest of this guide will explain how you might meet these requirements.

### **Who enforces the Fire Safety Order?**

The local Fire and Rescue Authority (the fire and rescue service) will enforce the Order<sup>1</sup> in most premises. The exceptions are:

- Crown-occupied/owned premises where Crown fire inspectors will enforce;
- premises within armed forces establishments where the defence fire and rescue service will enforce;
- certain specialist premises including construction sites, ships (under repair or construction) and nuclear installations, where the HSE will enforce; and
- sports grounds and stands designated as needing a safety certificate by the local authority, where the local authority will enforce.

The enforcing authority will have the power to inspect your premises to check that you are complying with your duties under the Order.<sup>1</sup> They will look for evidence that you have carried out a suitable fire risk assessment and acted upon the significant findings of that assessment. If, as is likely, you are required to record the outcome of the assessment they will expect to see a copy.

If the enforcing authority is dissatisfied with the outcome of your fire risk assessment or the action you have taken, they may issue an enforcement notice that requires you to make certain improvements or, in extreme cases, a prohibition notice that restricts the use of all or part of your premises until improvements are made.

If your premises are considered by the enforcing authority to be or have potential to be high risk, they may issue an alterations notice that requires you to inform them before you make any changes to your premises or the way they are used.

Failure to comply with any duty imposed by the Order<sup>1</sup> or any notice issued by the enforcing authority is an offence. You have a right of appeal to a magistrates court against any notice issued. Where you agree that there is a need for improvements to your fire precautions but disagree with the enforcing authority on the technical solution to be used (e.g. what type of fire alarm system is needed) you may agree to refer this for independent determination.

If, having read this guide, you are in any doubt about how fire safety law applies to you, contact the fire safety office at your local fire and rescue service.

If your premises were in use before 2006, then they may have been subject to the Fire Precautions Act<sup>2</sup> and the Fire Precautions (Workplace) Regulations.<sup>3,4</sup> Where the layout (means of escape) and other fire precautions have been assessed by the fire and rescue service to satisfy the guidance that was then current, it is likely that your premises already conform to many of the recommendations here, providing you have undertaken a fire risk assessment as required by the Fire Precautions (Workplace) Regulations.<sup>3,4</sup>

New buildings or significant building alterations should be designed to satisfy current building regulations<sup>24</sup> which address fire precautions. However, you will still need to carry out a fire risk assessment, or review your existing assessment (and act on your findings), to comply with the Order.<sup>1</sup>

# Part 1 Fire risk assessment

## MANAGING FIRE SAFETY

Good management of fire safety is essential to ensure that fires are unlikely to occur; that if they do occur they are likely to be controlled or contained quickly, effectively and safely; or that, if a fire does occur and grow, everyone in your premises is able to escape to a place of total safety easily and quickly.

The risk assessment that you must carry out will help you ensure that your fire safety procedures, fire prevention measures, and fire precautions (plans, systems and equipment) are all in place and working properly, and the risk assessment should identify any issues that need attention. Further information on managing fire safety is available in Part 2 on page 41.

## WHAT IS A FIRE RISK ASSESSMENT?

A fire risk assessment is an organised and methodical look at your premises, the activities carried on there and the likelihood that a fire could start and cause harm to those in and around the premises.

The aims of the fire risk assessment are:

- To identify the fire hazards.
- To reduce the risk of those hazards causing harm to as low as reasonably practicable.
- To decide what physical fire precautions and management arrangements are necessary to ensure the safety of people in your premises if a fire does start.

The term 'where necessary' (see Glossary) is used in the Order,<sup>1</sup> therefore when deciding what fire precautions and management arrangements are necessary you will need to take account of this definition.

The terms 'hazard' and 'risk' are used throughout this guide and it is important that you have a clear understanding of how these should be used.

- **Hazard:** anything that has the potential to cause harm.
- **Risk:** the chance of that harm occurring.

If your organisation employs five or more people, or your premises are licensed or an alterations notice requiring it is in force, then the significant findings of the fire risk assessment, the actions to be taken as a result of the assessment and details of anyone especially at risk must be recorded. You will probably find it helpful to keep a record of the significant findings of your fire risk assessment even if you are not required to do so.

## HOW DO YOU CARRY OUT A FIRE RISK ASSESSMENT?

A fire risk assessment will help you determine the chances of a fire starting and the dangers from fire that your premises present for the people who use them and any person in the immediate vicinity. The assessment method suggested in this guide shares the same approach as that used in general health and safety legislation and can be carried out either as part of a more general risk assessment or as a separate exercise. As you move through the steps there are checklists to help you.

Before you start your fire risk assessment, take time to prepare, and read through the rest of Part 1 of this guide.

Much of the information for your fire risk assessment will come from the knowledge your employees, colleagues and representatives have of the premises, as well as information given to you by people who have responsibility for other parts of the building. A tour of your premises will probably be needed to confirm, amend or add detail to your initial views.

It is important that you carry out your fire risk assessment in a practical and systematic way and that you allocate enough time to do a proper job. It must take the whole of your premises into account, including outdoor locations and any rooms and areas that are rarely used. If your premises are small you may be able to assess them as a whole. In larger premises you may find it helpful to divide them into rooms or a series of assessment areas using natural boundaries, e.g. process areas, offices, stores, as well as corridors, stairways and external routes.

If your premises are in a multi-use complex then the information on hazard and risk reduction will still be applicable to you. However, any alterations to the use or structure of your individual unit will need to take account of the overall fire safety arrangements in the building.

Your premises may be simple, with few people present or with a limited degree of business activity, but if it forms part of a building with different occupancies, then the measures provided by other occupiers may have a direct effect on the adequacy of the fire safety measures in your premises.

Under health and safety law (enforced by the HSE or the local authority) you are required to carry out a risk assessment in respect of any work processes in your workplace, and to take or observe appropriate special, technical or organisational measures. If your health and safety risk assessment identifies that these processes are likely to involve the risk of fire or the spread of fire, then you will need to take this into account during your fire risk assessment under the Order,<sup>1</sup> and prioritise actions based on the level of risk.

You need to appoint one or more competent persons (this could be you) to carry out any of the preventive and protective measures needed to comply with the Order.<sup>1</sup> This person could be you, or an appropriately trained employee or, where appropriate, a third party.

Your fire risk assessment should demonstrate that, as far as is reasonable, you have considered the needs of all relevant persons, including disabled people.

Figure 1 shows the five steps you need to take to carry out a fire risk assessment.

# FIRE SAFETY RISK ASSESSMENT

## 1 Identify fire hazards

### Identify:

Sources of ignition  
Sources of fuel  
Sources of oxygen

## 2 Identify people at risk

### Identify:

People in and around the premises  
People especially at risk

## 3 Evaluate, remove, reduce and protect from risk

Evaluate the risk of a fire occurring  
Evaluate the risk to people from fire  
Remove or reduce fire hazards  
Remove or reduce the risks to people

- Detection and warning
- Fire-fighting
- Escape routes
- Lighting
- Signs and notices
- Maintenance

## 4 Record, plan, inform, instruct and train

Record significant finding and action taken  
Prepare an emergency plan  
Inform and instruct relevant people; co-operate and co-ordinate with others  
Provide training

## 5 Review

Keep assessment under review  
Revise where necessary

**Remember to keep to your fire risk assessment under review.**

Figure 1: The five steps of a fire risk assessment

## STEP 1 IDENTIFY FIRE HAZARDS

For a fire to start, three things are needed:

- a source of ignition;
- fuel; and
- oxygen.

If any one of these is missing, a fire cannot start. Taking measures to avoid the three coming together will therefore reduce the chances of a fire occurring.

The remainder of this step will advise on how to identify potential ignition sources, the materials that might fuel a fire and the oxygen supplies which will help it burn.

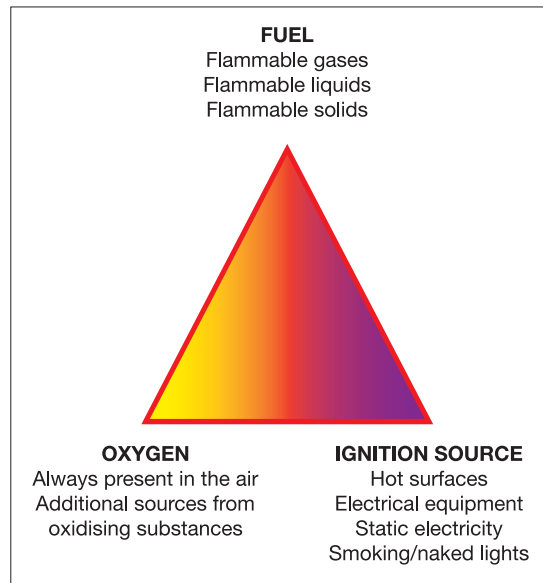

Figure 2: The fire triangle

### 1.1 Identify sources of ignition

You can identify the potential ignition sources in your premises by looking for possible sources of heat which could get hot enough to ignite material found in your premises. These sources could include:

- smokers' material, e.g. cigarettes, matches and lighters;
- naked flames, e.g. gas or liquid-fuelled open-flame equipment;
- sparks from burning products, e.g. bonfires in yards;
- vehicle exhausts;
- electrical, gas or oil-fired heaters (fixed or portable), room heaters;
- hot processes/hot work, e.g. welding by contractors or shrink wrapping;
- cooking equipment, hot ducting, flues and filters;
- extract fans for dust and fume removal systems, e.g. by build-up of debris;
- failure of temperature control thermostats on hot work/cooking processes;
- heat sources, such as gas, electric, microwaves, radio frequency, thermal fluids;
- steam pipes;
- frictional generated heat from mechanical equipment;
- static charge from mechanical equipment, e.g. conveyor belts;
- poor electrical installations, e.g. overloads, heating from bunched cables, damaged cable;
- faulty or misused electrical equipment, e.g. refrigeration defrost systems, fork lift truck charging units;

- light fittings and lighting equipment, e.g. halogen lamps or display lighting or overhead lights too close to stored products;
- hot surfaces and obstruction of equipment ventilation;
- spontaneous ignition and self heating, e.g. oil soaked rags, paint scrapings, crumb and batter residue; and
- arson.

Indications of 'near-misses', such as scorch marks on furniture or fittings, discoloured or charred electrical plugs and sockets, cigarette burns, etc., can help you identify hazards which you may not otherwise notice.

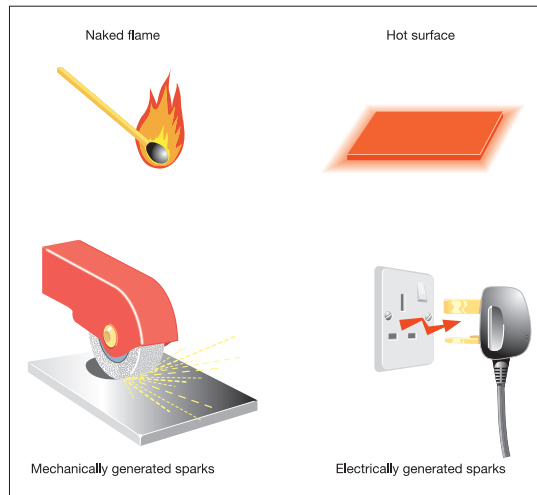

Figure 3: Sources of ignition

## 1.2 Identify sources of fuel

Anything that burns is fuel for a fire. You need to look for the things that will burn reasonably easily and are in enough quantity to provide fuel for a fire or cause it to spread to another fuel source. Some of the most common 'fuels' found in factories and warehouses are:

- flammable liquid-based products, such as paints, varnishes, thinners and adhesives;
- flammable liquids and solvents, such as petrol, white spirit, methylated spirit, cooking oils and disposable cigarette lighters;
- flammable chemicals, such as certain cleaning products, photocopier chemicals and dry cleaning products that use hydrocarbon solvents;
- flammable gases such as liquefied petroleum gas (LPG), flammable refrigerants and flammable gas propelled aerosols;
- stored goods and high piled or racked storage;
- foodstuffs containing sugar and oils, such as sugar-coated cereal and butter;
- plastics and rubber, such as video tapes, polyurethane foam-filled furniture and polystyrene-based display materials;
- paper products, such as stationery, advertising material and decorations;
- packaging materials;
- plastic and timber storage aids both in use and idle, such as pallets, octobins, and palletainers;
- combustible insulation, such as panels constructed with combustible cores;
- textiles and soft furnishings, such as hanging curtains and clothing displays; and
- waste products, particularly finely divided items such as shredded paper and wood shavings, offcuts, dust and litter/rubbish.

You should also consider the materials used to line walls and ceilings, e.g. polystyrene or carpet tiles, the fixtures and fittings, and how they might contribute to the spread of fire. Further information is available in Part 2, Section 1.

### 1.3 Identify sources of oxygen

The main source of oxygen for a fire is in the air around us. In an enclosed building this is provided by the ventilation system in use. This generally falls into one of two categories: natural airflow through doors, windows and other openings; or mechanical air conditioning systems and air handling systems. In many buildings there will be a combination of systems, which will be capable of introducing/extracting air to and from the building.

Additional sources of oxygen can sometimes be found in materials used or stored at premises such as:

- some chemicals (oxidising materials), which can provide a fire with additional oxygen and so help it burn. These chemicals should be identified on their container (and Control of Substances Hazardous to Health data sheet, see Figure 4) by the manufacturer or supplier who can advise as to their safe use and storage;
- oxygen supplies from cylinder storage and piped systems, e.g. oxygen used in welding processes; and
- pyrotechnics (fireworks), which contain oxidising materials and need to be treated with great care.



Figure 4: Label on oxidising materials

#### Checklist



- Have you identified all potential ignition sources?
- Have you identified all potential fuel sources?
- Have you identified all potential sources of oxygen?
- Have you made a note of your findings?

## STEP 2 IDENTIFY PEOPLE AT RISK

As part of your fire risk assessment, you need to identify those at risk if there is a fire. To do this you need to identify where you have people working, either at permanent locations (such as workstations) or at occasional locations around the premises, and to consider who else may be at risk, such as customers, visiting contractors, etc., and where these people are likely to be found.



You must consider all the people who use the premises, but you should pay particular attention to people who may be especially at risk such as:

- employees who work alone, e.g. cleaners, security staff;
- people who are in isolated areas, e.g. maintenance staff, staff on cranes, reach trucks and cat walks;
- unaccompanied children and young persons;
- people who are unfamiliar with the premises, e.g. seasonal workers, contractors, visitors and customers;
- people with disabilities\* or those who may have some other reason for not being able to leave the premises quickly;
- people with language difficulties; and
- other people in the immediate vicinity of the premises.

In evaluating the risk to people with disabilities you may need to discuss their individual needs with them. In larger premises used extensively for the public you may need to seek professional advice.

Further guidance on people with special needs is given in Part 2, Section 1.



#### Checklist

- Have you identified who is at risk?
- Have you identified why they are at risk?
- Have you made a note of your findings?

## STEP 3 EVALUATE, REMOVE, REDUCE AND PROTECT FROM RISK

The management of the premises and the way people use it will have an effect on your evaluation of risk. Management may be your responsibility alone or there may be others, such as the building owners or managing agents, who also have responsibilities. In multi-occupied buildings all those with some control must co-operate and you need to consider the risk generated by others in the building.

### 3.1 Evaluate the risk of a fire occurring

The chances of a fire starting will be low if your premises has few ignition sources and if combustible materials are kept away from them.

In general, fires start in one of three ways:

- accidentally, such as when smoking materials are not properly extinguished or when lighting displays are knocked over;
- by act or omission, such as when electrical equipment is not properly maintained, or when waste packaging is allowed to accumulate near to a heat source, or by storing LPG next to an electric fire or other source of heat; or

\*Visit the Disability Rights commission website on [www.drc-gb.org](http://www.drc-gb.org) for more information.

- deliberately, such as an arson attack involving setting fire to external rubbish bins placed too close to the building.

Look critically at your premises and try to identify any accidents waiting to happen and any acts or omissions which might allow a fire to start. You should also look for any situation that may present an opportunity for an arsonist.

Further guidance is given in Part 2, Section 1 on evaluating the risk of a fire starting.

### **3.2 Evaluate the risk to people**

In Step 2 you identified the people likely to be at risk should a fire start anywhere in the premises and earlier in Step 3 you identified the chances of a fire occurring. It is unlikely that you will have concluded that there is no chance of a fire starting anywhere in your premises so you now need to evaluate the actual risk to those people should a fire start and spread from the various locations that you have identified.

While determining the possible incidents, you should also consider the likelihood of any particular incident; but be aware that some very unlikely incidents can put many people at risk.

To evaluate the risk to people in your premises, you will need to understand the way fire can spread. Fire is spread by three methods:

- convection;
- conduction; and
- radiation.

#### **Convection**

Fire spread by convection is the most dangerous and causes the largest number of injuries and deaths. When fires start in enclosed spaces such as buildings, the smoke rising from the fire gets trapped by the ceiling and then spreads in all directions to form an ever-deepening layer over the entire room space. The smoke will pass through any holes or gaps in the walls, ceiling and floor into other parts of the building. The heat from the fire gets trapped in the building and the temperature rises.

#### **Conduction**

Some materials, such as metal shutters and ducting, can absorb heat and transmit it to the next room, where it can set fire to combustible items that are in contact with the heated material.

#### **Radiation**

Radiation heats the air in the same way as an electric bar heater heats a room. Any material close to a fire will absorb the heat until the item starts to smoulder and then burn.

Smoke produced by a fire also contains toxic gases which are harmful to people. A fire in a building with modern fittings and materials generates smoke that is thick and black, obscures vision, causes great difficulty in breathing and can block the escape routes.

It is essential that the means of escape and other fire precautions are adequate to ensure that everyone can make their escape to a place of total safety before the fire and its effects can trap them in the building.

In evaluating this risk to people you will need to consider situations such as:

- fire starting on a lower floor affecting the only escape route for people on upper floors or the only escape route for people with disabilities;
- fire starting in a service room and affecting hazardous materials (such as pyrotechnics or gas cylinders);
- fire developing in an unoccupied space that people have to pass by to escape from the building;
- fire spreading rapidly through the building because of combustible structural elements and/or large quantities of combustible goods;
- rapid vertical fire spread in high rack storage;
- fire or smoke spreading through a building via routes such as vertical shafts, service ducts, ventilation systems, poorly installed, poorly maintained or damaged, walls, partitions and ceilings;
- fire and smoke spreading through a building due to poor installation of fire precautions, e.g. incorrectly installed fire doors (see Appendix B2 for more information on fire doors) or incorrectly installed services penetrating fire walls; and
- fire and smoke spreading through the building due to poorly maintained and damaged fire doors or fire doors being wedged open.

Further guidance on fire risks is given in Part 2, Section 1.

### 3.3 Remove or reduce the hazards

Having identified the fire hazards in Step 1, you now need to remove those hazards if reasonably practicable to do so. If you cannot remove the hazards, you need to take reasonable steps to reduce them if you can. This is an essential part of fire risk assessment and as a priority this must take place before any other actions.

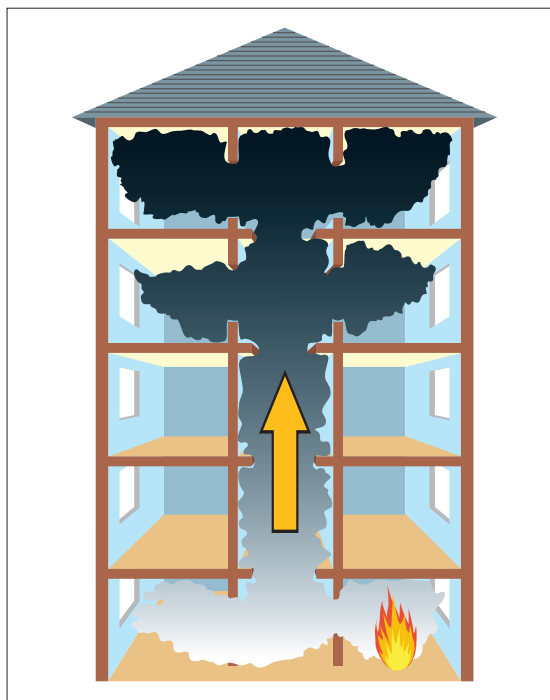

Figure 5: Smoke moving through a building

Ensure that any actions you take to remove or reduce fire hazards or risk are not substituted by other hazards or risks. For example, if you replace a flammable substance with a toxic or corrosive one, you must consider whether this might cause harm to people in other ways.

### **Remove or reduce sources of ignition**

There are various ways that you can reduce the risk caused by potential sources of ignition, for example:

- Wherever possible replace a potential source by a safer alternative.
- Operate a safe smoking policy in designated smoking areas and prohibit smoking elsewhere.
- Replace naked flame and radiant heaters with fixed convector heaters or a central heating system. Restrict the movement of and guard portable heating appliances.
- Separate ignition hazards and combustibles, e.g. ensure sufficient clear space between lights and combustibles, build fire-resistant enclosures for hot processes, incinerate rubbish off site.
- Inspect and monitor ignition hazards so that preventative corrective actions can be undertaken, e.g. sample temperature on ducts and in oil baths, inspect for hot spots in electrical systems and mechanical systems.
- Ensure electrical, mechanical and gas equipment is installed, used, maintained and protected in accordance with the manufacturer's instructions.
- Strictly control hot processes/hot work by operating permit to work schemes.
- Check all areas where hot work (e.g. welding) has been carried out to ensure that no ignition has taken place and no smouldering or hot materials remain that may cause a fire.
- Ensure that no one carrying out work on gas fittings which involves exposing pipes that contain or have contained flammable gas uses any source of ignition such as blow-lamps or hot-air guns.
- Ensure that no one uses any source of ignition while searching for an escape of gas.
- Take precautions to avoid arson.

### **Remove or reduce sources of fuel**

There are various ways that you can reduce the risks caused by materials and substances which burn, for example:

- Reduce stocks of flammable materials, liquids and gases in open areas to a minimum. Keep remaining stock in dedicated storerooms or storage areas, preferably outside, where only the appropriate staff are allowed to go, and keep the minimum required for the operation of the business.
- Do not keep flammable solids, liquids and gases together.
- Keep areas containing flammable gases ventilated, e.g. fork lift truck charging units.

- Ensure flammable materials, liquids and gases, are kept to a minimum, and are stored properly with adequate separation distances between them.
- Ensure adequate aisle is maintained separation between stacks of stored goods.
- Separate fuel into fire-resistant enclosures, e.g. store raw materials and finished goods separately.
- Use non-combustible building materials for building modifications.
- Remove, or treat large areas of highly combustible wall and ceiling linings, e.g. polystyrene or carpet tiles, to reduce the rate of flame spread across the surface.
- Develop a formal system for the control of combustible waste by ensuring that waste materials and rubbish are not allowed to build up and are carefully stored until properly disposed of, particularly at the end of the day.
- Take action to avoid any parts of the premises, and in particular storage areas, being vulnerable to arson or vandalism.
- Check all areas where hot work (e.g. welding) has been carried out to ensure that no ignition has taken place and no smouldering or hot materials remain that may cause a fire later.

Further guidance on removing and reducing hazards is given in Part 2, Section 1.

The fuel hazard can also be reduced by the installation of automatic sprinkler systems or other suppression/ extinguishing systems, further guidance is available in Part 2, Section 3. The provision of such systems may have been a requirement of a local act or engineered solution and must be maintained.

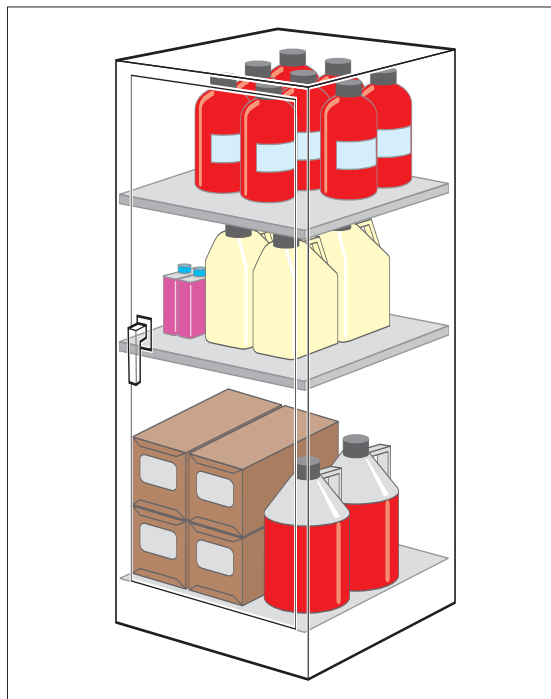

Figure 6: Storage of flammables

### Remove or reduce sources of oxygen

You can reduce the potential source of oxygen supplied to a fire by:

- closing all doors, windows and other openings not required for ventilation, particularly out of working hours;
- shutting down ventilation systems which are not essential to the function of the premises;
- not storing oxidising materials near or within any heat source or flammable materials; and
- controlling the use and storage of oxygen cylinders, ensuring that they are not leaking, are not used to 'sweeten' the atmosphere, and that where they are located is adequately ventilated.

### **3.4 Remove or reduce the risks to people**

Having evaluated and addressed the risk of fire occurring and the risk to people (preventative measures) it is unlikely that you will be able to conclude that no risk remains of a fire starting and presenting a risk to people in your premises.

You now need to reduce any remaining fire risk to people to as low as reasonably practicable, by ensuring that adequate fire precautions are in place to warn people in the event of a fire and allow them to safely escape.

The rest of this step describes the fire protection measures you may wish to adopt to reduce the remaining fire risk to people (see Steps 3.4.1 to 3.4.6).

The level of fire protection you need to provide will depend on the level of risk that remains in the premises after you have removed or reduced the hazards and risks. Part 2, Section 4.1 can help you decide the level of risk that you may still have.

#### **Flexibility of fire protection measures**

Flexibility will be required when applying this guidance; the level of fire protection should be proportional to the risk posed to the safety of the people in the premises. Therefore, the objective should be to reduce the remaining risk to a level as low as reasonably practicable. The higher the risk of fire and risk to life, the higher the standards of fire protection will need to be.

Your premises may not exactly fit the solutions suggested in this guide and they may need to be applied in a flexible manner without compromising the safety of the occupants.

For example, if the 'travel distance' is in excess of the norm for the level of risk you have determined (see Part 2, Table 2 on page 71), it may be necessary to do any one or a combination of the following to compensate:

- Provide earlier warning of fire using automatic fire detection.
- Revise the layout to reduce travel distances.
- Reduce the fire risk by removing or reducing combustible materials and/or ignition sources.
- Control the number of people in the premises.
- Limit the area to trained staff only (no public).
- Increase staff training and awareness.

**Note:** The above list is not exhaustive and is only used to illustrate some examples of trade-offs to provide safe premises.

**If you decide to significantly vary away from the benchmarks in this guidance then you should seek expert advice before doing so.**

### 3.4.1 Fire-detection and warning systems

In some simple, open-plan, single-storey factories and warehouses, a fire may be obvious to everyone as soon as it starts. In these cases, where the number and position of exits and the travel distance to them is adequate, a simple shout of 'fire' or a simple manually operated device, such as a gong, whistle or air horn that can be heard by everybody when operated from any single point within the building, may be all that is needed. Where a simple shout or manually operated device is not adequate, it is likely that an electrical fire warning system will be required.

In more complex premises, particularly those with more than one floor, where an alarm given from any single point is unlikely to be heard throughout the building, an electrical system incorporating sounders and manually operated call points (break-glass boxes) is likely to be required. This type of system is likely to be acceptable where all parts of the building are occupied at the same time and it is unlikely that a fire could start without somebody noticing it quickly. However, where there are unoccupied areas, or common corridors and circulation spaces in multi-occupied premises, in which a fire could develop to the extent that escape routes could be affected before the fire is discovered, automatic fire detection may be necessary.

The use of these systems may also be risk dependent, so a small factory or warehouse which handles, manufactures, stores or uses low flash point or highly flammable hazardous substances might also need an automatic fire detection system.

You may need to consider special arrangements for times when people are working alone, are disabled, or when your normal occupancy patterns are different, e.g. when maintenance staff or other contractors are working at the weekend.

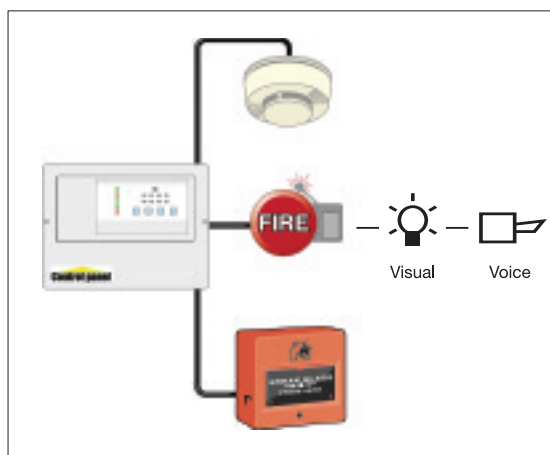

*Figure 7: Fire detection and warning system*

In large or complex premises, particularly those accommodating large numbers of people, it is likely that a more sophisticated form of warning and evacuation, possibly phased, should be provided.

False alarms from electrical fire warning systems are a major problem (e.g. malicious activation of manual call points) and result in many unwanted calls to the fire and rescue service every year. To help reduce the number of false alarms, the design and location of activation devices should be reviewed against the way the premises are currently used.

If you are not sure whether your current arrangements are adequate, see the additional guidance on fire warning systems in Part 2, Section 2.







### Checklist

- Can the existing means of detection ensure a fire is discovered quickly enough for the alarm to be raised in time for all the occupants to escape to a place of total safety?
- Are the detectors of the right type and in the appropriate locations?
- Can the means of warning be clearly heard and understood by everyone throughout the whole building when initiated from a single point? Are there provisions for people or locations where the alarm cannot be heard?
- If the fire-detection and warning system is electrically powered, does it have a back-up power supply?

### 3.4.2 Firefighting equipment and facilities

Firefighting equipment can reduce the risk of a small fire, e.g. a fire in a waste-paper bin, developing into a large one. The safe use of an appropriate fire extinguisher to control a fire in its early stages can also significantly reduce the risk to other people in the premises by allowing people to assist others who are at risk.

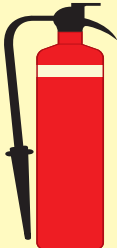
This equipment will need to comprise enough portable extinguishers that must be suitable for the risk.

Main types of portable extinguishers, their uses and colour coding			
<b>WATER</b> For wood, paper, textile and solid material fires	<b>POWDER</b> For liquid and electrical fires	<b>FOAM</b> For use on liquid fires	<b>CARBON DIOXIDE (CO<sub>2</sub>)</b> For liquid and electrical fires
			
<b>DO NOT USE on liquid, electrical or metal fires</b>	<b>DO NOT USE on metal fires</b>	<b>DO NOT USE on electrical or metal fires</b>	<b>DO NOT USE on metal fires</b>

The contents of an extinguisher is indicated by a zone of colour on the red body.  
Halon extinguishers are not shown since no new Halon production is permitted in the UK

Figure 8: Types of fire extinguishers



In simple premises, having one or two portable extinguishers of the appropriate type, readily available for use, may be all that is necessary. In more complex premises, a number of portable extinguishers may be required and they should be sited in suitable locations, e.g. on the escape routes at each floor level. It may also be necessary to indicate the location of extinguishers by suitable signs.

Some premises will also have permanently installed firefighting equipment such as hose reels, for use by trained staff or firefighters.

People with no training should not be expected to attempt to extinguish a fire. However, all staff should be familiar with the location and basic operating procedures for the equipment provided, in case they need to use it. If your fire strategy means that certain people, e.g. fire marshals, will be expected to take a more active role, then they should be provided with more comprehensive training.

Other fixed installations and facilities to assist firefighters, such as dry rising mains and access for fire engines, or automatically operated, fixed fire suppression systems such as sprinklers and gas or foam flooding systems, may also have been provided.

Where these have been required by law, e.g. the Building Regulations or local Acts, such equipment and facilities must be maintained.

Similarly, if provided for other reasons, e.g. insurance, it is good practice to ensure that they are properly maintained.

In most cases it will be necessary to consult a competent service engineer. Keeping records of the maintenance carried out will help you demonstrate to the enforcing authority that you have complied with fire safety law.

Appendix A1 provides a sample fire safety maintenance checklist you can use.

For more guidance on portable fire extinguishers see Part 2, Section 3.1 for fixed firefighting installations, Part 2, Section 3.2, and other facilities (including those for firefighters) see Part 2, Section 3.3.



### Checklist

- Are the portable fire extinguishers or any fixed firefighting equipment provided suitable for controlling the risks identified?
- Are there enough extinguishers sited throughout the premises at appropriate locations?
- Are the right types of extinguishers located close to the fire hazards and can users get to them without exposing themselves to risk?
- Are the extinguishers visible or does their position need indicating?
- Have you taken steps to prevent the misuse of extinguishers?
- Do you regularly check equipment provided to help maintain the escape routes?
- Do you carry out daily checks to ensure that there is clear access for fire engines?
- Are those who test and maintain the equipment competent to do so?
- Do you have the necessary procedures in place to maintain any facilities that have been provided for the safety of people in the building (or for the use of firefighters, such as access for fire engines and firefighting lifts)?

### 3.4.3 Escape routes

Once a fire has started, been detected and a warning given, everyone in your premises should be able to escape to a place of total safety unaided and without the help of the fire and rescue service. However, some people with disabilities and others with special needs may need help from staff who will need to be designated for the purpose.

Escape routes should be designed to ensure, as far as possible, that any person confronted by fire anywhere in the building, should be able to turn away from it and escape to a place of reasonable safety, e.g. a protected stairway. From there they will be able to go directly to a place of total safety away from the building.

Those who require special assistance (e.g. very young children in a creche and some people with disabilities) could be accommodated on the same level as the final exit from the premises to facilitate escape. Where they need assistance to evacuate, you should make sure that there are sufficient staff to ensure a speedy evacuation.

The level of fire protection that should be given to escape routes will vary depending on the level of risk of fire within the premises and other related factors. Generally, premises that are simple, consisting of a single storey, will require fairly simple measures to protect the escape routes, compared to a large multi-storey building, which would require a more complex and inter-related system of fire precautions.

When determining whether your premises have adequate escape routes, you need to consider a number of factors, including:

- the type and number of people using the premises;
- escape time;
- the age and construction of the premises;
- the number and complexity of escape routes and exits;
- whether lifts can or need to be used;
- the use of phased or delayed alarm evacuation;
- assisted means of escape/personal evacuation plans (PEEPs); and
- assembly points.

### **The type and number of people using the premises**

The people present in your premises will primarily be employees. Employees can reasonably be expected to have an understanding of the layout of the premises, while contractors or visitors will be unlikely to have knowledge of alternative escape routes.

The number and capability of people present will influence your assessment of the escape routes. You must ensure that your existing escape routes are sufficient and capable of safely evacuating all the people likely to use your premises at any time, including temporary staff employed in busy periods, and visitors. If necessary you may need either to increase the capacity of the escape routes or restrict the number of people in the premises.

### **Escape time**

In the event of a fire, it is important to evacuate people as quickly as possible from the premises. Escape routes in a building should be designed so that people can escape quickly enough to ensure they are not placed in any danger from fire. The time available will depend on a number of factors, including how quickly the fire is detected and the alarm raised, the number of escape routes available, the nature of the occupants and the speed of fire growth. In high rack storage the spread of fire vertically will be rapid, so this risk should be given special consideration. For simplicity, the travel distances in Part 2, Table 2 on page 71 take these factors into account. Part 2, Section 4.1 will help you decide the level of risk in your premises for escape purposes.

### **The age and construction of the premises**

Older buildings may comprise different construction materials from newer buildings, and may be in a poorer state of repair. The materials from which your premises are constructed, the quality of building work and state of repair could contribute to the speed with which any fire may spread, and potentially affect the escape routes the occupants will need to use. A fire starting in a building constructed mainly from combustible material will spread faster than one where fire-resisting construction

materials have been used.

If you wish to construct internal partitions or walls in your premises, perhaps to divide up a work area, you should ensure that any new partition or wall does not obstruct any escape routes or fire exits, extend travel distances or reduce the sound levels of the fire alarm system. Any walls that affect the means of escape should be constructed of appropriate material. (Further technical information is provided in Appendix B.)

Depending on the findings of your fire risk assessment, it may be necessary to protect the escape routes against fire and smoke by upgrading the construction of the floors, ceiling and walls to be a fire-resisting standard. You should avoid having combustible wall and ceiling linings in your escape routes. For further information see Appendix B. You may need to seek advice from a competent person. Any structural alterations may require building regulation approval.

### **The number of escape routes and exits**

In general there should normally be at least two escape routes from all parts of the premises, but a single escape route may be acceptable in some circumstances (e.g. part of your premises accommodating less than 60 people or where the travel distances are limited).

Where two escape routes are necessary and to further minimise the risk of people becoming trapped, you should ensure that the escape routes are completely independent of each other. This will prevent a fire affecting more than one escape route at the same time.

When evaluating escape routes, you may need to build in a safety factor by discounting the largest exit from your escape plan or doors which cannot be opened quickly, e.g. manually operated roller shutters. You can then determine whether the remaining escape routes from a room, floor or building will be sufficient to evacuate all the occupants within a reasonable time. Escape routes that provide escape in a single direction only may need additional fire precautions to be regarded as adequate.

Exit doors on escape routes and final exit doors should normally open in the direction of travel, and be quickly and easily openable without the need for a key. Checks should be made to ensure final exits are wide enough to accommodate the number of people who may use the escape routes they serve.

## Management of escape routes

It is essential that escape routes, and the means provided to ensure they are used safely, are managed and maintained to ensure that they remain usable and available at all times when the premises are occupied. Inform staff in training sessions about the escape routes within the premises.



Figure 9:  
*A blocked corridor*

Corridors and stairways that form part of escape routes should be kept clear and hazard free at all times. Items that may be a source of fuel or pose an ignition risk should never be located on any corridor or stairway that will be used as an escape route. In some premises with storage racking, escape routes may be through/under the racking; these should be kept clear of any storage and obstructions. Further guidance is available in Part 2, Section 4.

## Emergency evacuation of persons with mobility impairment

The means of escape you provide must be suitable for the evacuation of everyone likely to be in your premises. This may require additional planning and allocation of staff roles – with appropriate training. Provisions for the emergency evacuation of disabled persons may include:

- stairways;
- evacuation lifts;
- firefighting lifts;
- horizontal evacuation;
- refuges; and
- ramps.

Use of these facilities will need to be linked to effective management arrangements as part of your emergency plan. The plan should not rely on fire and rescue service involvement for it to be effective.

Further guidance on escape routes is available in Part 2, Section 4.



### Checklist

- Is your building constructed, particularly in the case of multi-storey buildings, so that, if there is a fire, heat and smoke will not spread uncontrolled through the building to the extent that people are unable to use the escape routes?
- Are any holes or gaps in walls, ceilings and floors properly sealed, e.g. where services such as ventilation ducts and electrical cables pass through them?
- Can all the occupants escape to a place of total safety in a reasonable time?
- Are the existing escape routes adequate for the numbers and type of people that may need to use them, e.g. staff, contractors and disabled people?
- Are the exits in the right place and do the escape routes lead as directly as possible to a place of total safety?
- If there is a fire, could all available exits be affected or will at least one route from any part of the premises remain available?
- Are the escape routes and final exits kept clear at all times?
- Do the doors on escape routes open in the direction of escape?
- Can all final exit doors be opened easily and immediately if there is an emergency?
- Will everybody be able to safely use the escape routes from your premises?
- Are the people who work in the building aware of the importance of maintaining the safety of the escape routes, e.g. by ensuring that fire doors are not wedged open and that combustible materials are not stored within escape routes?
- Are there any particular or unusual issues to consider?

#### 3.4.4 Emergency escape lighting

People in your premises must be able to find their way to a place of total safety if there is a fire by using escape routes that have enough lighting. Where any escape routes are internal and without windows, or your premises are used during periods of darkness, including early darkness on winter days, then some form of back-up to the normal escape route lighting (emergency escape lighting) is likely to be required.

In simple premises, e.g. small single storey open plan factories or warehouses with small numbers of staff where the escape routes are straightforward, borrowed lighting, e.g. from street lamps where they illuminate escape routes, may be acceptable. Where borrowed lighting is not available, suitably placed torches may be acceptable.

In larger, more complex premises it is likely that a more comprehensive system of electrical automatic emergency escape lighting will be needed to illuminate all the escape routes.

Where people have difficulty seeing conventional signs, a ‘way-guidance’ system may need to be considered.

Further guidance on emergency escape lighting is given in Part 2, Section 5.



#### Checklist

- Are your premises used during periods of darkness?
- Will there always be sufficient lighting to safely use escape routes?
- Do you have back-up power supplies for your emergency lighting?

### 3.4.5 Signs and notices

#### Signs

Signs must be used, where necessary, to help people identify escape routes, find firefighting equipment and emergency fire telephones. These signs are required under the Health and Safety (Safety Signs and Signals) Regulations 1996<sup>5, 6</sup> and must comply with the provisions of those Regulations.

A fire risk assessment that determines that no escape signs are required (because, for example, trained staff will always be available to help visitors to escape routes), is unlikely to be acceptable to an enforcing authority other than in the smallest and simplest of premises where the exits are in regular use and familiar to employees and visitors.

For a sign to comply with these Regulations it must be in pictogram form (see Figure 10). The pictogram can be supplemented by text if this is considered necessary to make the sign more easily understood, but you must not have a safety sign that uses only text.



Figure 10: Typical fire exit sign

Where the locations of escape routes and firefighting equipment are readily apparent and the firefighting equipment is visible at all times, then signs are not necessary. In all other situations it is likely that the fire risk assessment will indicate that signs will be necessary.

## Notices

Notices must be used, where necessary, to provide the following:

- instructions on how to use any fire safety equipment;
- the actions to be taken in the event of fire; and
- help for the fire and rescue service (e.g. location of sprinkler valves or electrical cut-off switches).

All signs and notices should be positioned so that they can be easily seen and understood.

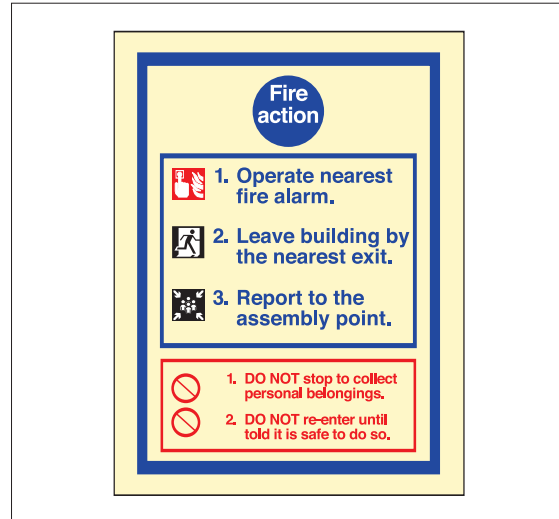

Figure 11: Simple fire action notice

Further guidance on signs and notices is given in Part 2, Section 6.

## Checklist



- Where necessary, are escape routes and exits, the locations of firefighting equipment and emergency telephones indicated by appropriate signs?
- Have you provided notices such as those giving information on how to operate security devices on exit doors, those indicating doors enclosing fire hazards that must be kept shut and fire action notices for staff and other people?
- Are you maintaining all the necessary signs and notices so that they continue to be correct, legible and understood?
- Are you maintaining signs that you have provided for the information of the fire and rescue service, such as those indicating the location of water suppression stop valves and the storage of hazardous substances?

### 3.4.6 Installation, testing and maintenance

New fire precautions should be installed by a competent person.

You must keep any existing equipment, devices or facilities that are provided in your premises for the safety of people, such as fire alarms, fire extinguishers, lighting, signs, fire exits and fire doors, in effective working order, and maintain fire separating elements designed to prevent fire and smoke entering escape routes.

You must ensure regular checks, periodic servicing and maintenance are carried out whatever the size of your premises, and any defects are put right as quickly as possible.

You, or a person you have nominated, can carry out certain checks and routine maintenance work. Further maintenance may need to be carried out by a competent



service engineer. Where contractors are used, third party certification is one method where a reasonable assurance of quality of work and competence can be achieved (see Part 2, Section 8).

The following are examples of checks and tests that should be considered. The examples of testing and maintenance given are not intended to be prescriptive and other testing regimes may be appropriate.

### **Daily checks**

Remove bolts, padlocks and security devices from fire exits, ensure that doors on escape routes swing freely and close fully, and check escape routes to ensure they are clear from obstructions and combustibile materials, and in a good state of repair. Open all final exit doors to the full extent and walk exterior escape routes. Check the fire alarm panel to ensure the system is active and fully operational. Where practicable, visually check that emergency lighting units are in good repair and apparently working. Check that all safety signs and notices are legible. (See Appendix B3 for more details on bolts, padlocks and security devices.)

### **Weekly tests and checks**

Test fire-detection and warning systems and manually-operated warning devices weekly following the manufacturer's or installer's instructions. Carry out smoke control and sprinkler tests. Fire pumps and standby diesel engines should be tested for 30 minutes each week. Check the batteries of safety torches and that fire extinguishers and hose reels are correctly located and in apparent working order.

### **Monthly tests and checks**

Test all emergency lighting systems and safety torches to make sure they have enough charge and illumination according to the manufacturer's or supplier's instructions. This should be at an appropriate time when, following the test, they will not be immediately required.

Check that all fire doors are in good working order and closing correctly and that the frames and seals are intact.

### **Six-monthly tests and checks**

A competent person should test and maintain the fire-detection and warning system.

### **Annual tests and checks**

The emergency lighting and all firefighting equipment, fire alarms and other installed sprinkler and smoke control systems should be tested and maintained by a competent person.

All structural fire protection and elements of fire compartmentation should be inspected and any remedial action carried out. Specific guidance on the maintenance of timber fire-resisting doors is given in Appendix B2.

Appendix A1 provides an example of a fire safety maintenance checklist. You will find it useful to keep a log book of all maintenance and testing.

Further guidance on maintenance and testing on individual types of equipment and facilities can be found in the relevant section in Part 2.

### Checklist



- Do you regularly check all fire doors and escape routes and associated lighting and signs?
- Do you regularly check all your firefighting equipment?
- Do you regularly check your fire-detection and alarm equipment?
- Are those who test and maintain the equipment competent to do so?
- Do you keep a log book to record tests and maintenance?

### Step 3 Checklist



#### Evaluate, remove, reduce and protect from risks by:

- Evaluating the risk to people in your building if a fire starts.
- Removing or reducing the hazards that might cause a fire. 
  - Have you:
    - Removed or reduced sources of ignition?
    - Removed or reduced sources of fuel?
    - Removed or reduced sources of air or oxygen?
  - Have you removed or reduced the risks to people if a fire occurs by:
    - Considering the need for fire detection and for warning?
    - Considering the need for firefighting equipment?
    - Determining whether your escape routes are adequate?
    - Determining whether your lighting and emergency lighting are adequate?
    - Checking that you have adequate signs and notices?
    - Regularly testing and maintaining safety equipment?
    - Considering whether you need any other equipment or facilities?

## STEP 4 RECORD, PLAN, INFORM, INSTRUCT AND TRAIN

In Step 4 there are four further elements of the risk assessment you should focus on to address the management of fire safety in your premises. In some premises with simple layouts this could be done as part of the day-to-day management; however, as the premises or the organisation get larger it may be necessary for a formal structure and written policy to be developed. Further guidance on managing fire safety is given in Part 2 on page 41.

### 4.1 Record the significant findings and action taken

If you or your organisation employ five or more people, your premises are licensed, or an alterations notice requiring you to do so is in force, you must record the significant findings of your fire risk assessment and the actions you have taken.

Significant findings should include details of:

- the fire hazards you have identified (you don't need to include trivial things like a small tin of solvent-based glue);
- the actions you have taken or will take to remove or reduce the chance of a fire occurring (preventive measures);
- persons who may be at risk, particularly those especially at risk;
- the actions you have taken or will take to reduce the risk to people from the spread of fire and smoke (protective measures);
- the actions people need to take in case of fire, including details of any persons nominated to carry out a particular function (your emergency plan); and
- the information, instruction and training you have identified that people need and how it will be given.

You may also wish to record discussions you have had with staff or staff representatives (including trade unions).

Even where you are not required to record the significant findings, it is good practice to do so.

In some simple premises, record keeping may be no more than a few sheets of paper (possibly forming part of a health and safety folder), containing details of significant findings, any action taken and a copy of the emergency plan.

The record could take the form of a simple list which may be supported by a simple plan of the premises (see Figure 12).

In more complex premises, it is best to keep a dedicated record including details of significant findings, any action taken, a copy of the emergency plan, maintenance of fire-protection equipment and training. There is no one 'correct' format specified for this. Further guidance is given in Part 2, Section 7.1.

You must be able to satisfy the enforcing authority, if called upon to do so, that you have carried out a suitable and sufficient fire risk assessment. Keeping records will help you do this and will also form the basis of your subsequent reviews. If you keep records, you do not need to record all the details, only those that are significant and the action you have taken.

It might be helpful to include a simple line drawing. This can also help you check your fire precautions as part of your ongoing review.



Figure 12: Example of a line drawing showing general fire safety precautions

The findings of your fire risk assessment will help you to develop your emergency plan, the instruction, information and training you need to provide; the co-operation and co-ordination arrangements you may need to have with other responsible people and the arrangements for maintenance and testing of the fire precautions. If you are required to record the significant findings of your fire risk assessment then these arrangements must also be recorded.

Further guidance about fire safety records with an example is given in Part 2, Section 7.1.

### Checklist



- Have you recorded the significant findings of your assessment?
- Have you recorded what you have done to remove or reduce the risk?
- Are your records available for inspection by the enforcing authority?

## 4.2 Emergency plans

You need to have an emergency plan for dealing with any fire situation.

The purpose of an emergency plan is to ensure that the people in your premises know what to do if there is a fire and that the premises can be safely evacuated.

If you or your organisation employ five or more people, or your premises are licensed or an alterations notice requiring it is in force, then details of your emergency plan must be recorded. Even if it is not required, it is good practice to keep a record.

Your emergency plan should be based on the outcome of your fire risk assessment and be available for your employees, their representatives (where appointed) and the enforcing authority.

In simple premises the emergency plan may be no more than a fire action notice.

In multi-occupied, larger and more complex premises, the emergency plan will need to be more detailed and compiled only after consultation with other occupiers and other responsible people, e.g. owners, who have control over the building. In most cases this means that an emergency plan covering the whole building will be necessary. It will help if you can agree on one person to co-ordinate this task.

Further guidance on emergency plans is given in Part 2, Section 7.2.

### Checklist



- Do you have an emergency plan and, where necessary, have you recorded the details?
- Does your plan take account of other emergency plans applicable to the same building?
- Is the plan readily available for staff to read?
- Is the emergency plan available to the enforcing authority?

## 4.3 Inform, instruct, co-operate and co-ordinate

You must give clear and relevant information and appropriate instructions to your staff and the employers of other people working in your premises, such as contractors, about how to prevent fires and what they should do if there is a fire.

If you intend to employ a child, you must inform the parents of the significant risks you have identified and the precautions you have taken. You must also co-operate and co-ordinate with other responsible people who use any part of the premises. It is unlikely that your emergency plan will work without this.

### Information and instruction

All staff should be given information and instruction as soon as possible after they are appointed and regularly after that. Make sure you include staff who work outside normal working hours, such as cleaners or maintenance staff.

All other relevant persons should be given information about the fire safety arrangements as soon as possible, e.g. contractors when they start work.

The information and instructions you give must be in a form that can be used and understood. They should take account of those with disabilities such as hearing or sight impairment, those with learning difficulties and those who do not use English as their first language.

The information and instruction you give should be based on your emergency plan and must include:

- the significant findings from your fire risk assessment;
- the measures that you have put in place to reduce the risk;
- what staff should do if there is a fire;
- the identity of people you have nominated with responsibilities for fire safety; and
- any special arrangements for serious and imminent danger to persons from fire.

In simple premises, where no significant risks have been identified and there are limited numbers of staff, information and instruction may simply involve an explanation of the fire procedures and how they are to be applied. This should include showing staff the fire-protection arrangements, including the designated escape routes, the location and operation of the fire-warning system and any other fire-safety equipment provided, such as fire extinguishers. Fire action notices can complement this information and, where used, should be posted in prominent locations.

In complex premises, particularly those in multi-occupied buildings, you should ensure that written instructions are given to people who have been nominated to carry out a designated safety task, such as calling the fire and rescue service or checking that exit doors are available for use at the start of each working day.

Further guidance on information and instruction to staff, and on working with dangerous substances, is given in Part 2, Section 7.3.

### **Co-operation and co-ordination**

In premises that are not multi-occupied you are likely to be solely responsible. However, in buildings owned by someone else, or where there is more than one occupier, and others are responsible for different parts of the building, it is important that you liaise with them and inform them of any significant risks that you have identified. By liaising you can co-ordinate your resources to ensure that your actions and working practices do not place others at risk if there is a fire, and a co-ordinated emergency plan operates effectively.

Where two or more responsible persons share premises in which an explosive atmosphere may occur, the responsible person with overall responsibility for the premises must co-ordinate any measures necessary to protect everyone from any risk that may arise. Employees also have a responsibility to co-operate with their employer so far as it is necessary to help the employer comply with any legal duty.

Further guidance on co-operation and co-ordination is given in Part 2, Section 7.3.



### Checklist

- Have you told your staff about the emergency plan?
- Have you informed guests and visitors about what to do in an emergency?
- Have you identified people you have nominated to do a particular task?
- Have you given staff information about any dangerous substances?
- Do you have arrangements for informing temporary or agency staff?
- Do you have arrangements for informing other employers whose staff are guest workers in your premises, such as maintenance contractors and cleaners?
- Have you co-ordinated your fire safety arrangements with other responsible people and with any contractors in the building?
- Have you recorded details of any information or instructions you have given and the details of any arrangements for co-operation and co-ordination with others?

#### 4.4 Fire safety training

You must provide adequate fire safety training for your staff. The type of training should be based on the particular features of your premises and should:

- take account of the findings of the fire risk assessment;
- explain your emergency procedures;
- take account of the work activity and explain the duties and responsibilities of staff;
- take place during normal working hours and be repeated periodically where appropriate;
- be easily understandable by your staff and other people who may be present; and
- be tested by fire drills.

In simple premises this may be no more than showing new staff the fire exits and giving basic training on what to do if there is a fire. In complex premises with a high staff turnover and many shift patterns, the organisation of fire safety training will need to be planned.

Your training should include the following:

- what to do on discovering a fire;
- how to raise the alarm and what happens then;
- what to do upon hearing the fire alarm;
- the procedures for alerting contractors and visitors including, where appropriate, directing them to exits;
- the arrangements for calling the fire and rescue service;

- the evacuation procedures for everyone in your factory or warehouse to reach an assembly point at a place of total safety;
- the location and, when appropriate, the use of firefighting equipment;
- the location of escape routes, especially those not in regular use;
- how to open all emergency exit doors;
- the importance of keeping fire doors closed to prevent the spread of fire, heat and smoke;
- where appropriate, how to stop machines and processes and isolate power supplies in the event of a fire;
- the reason for not using lifts (except those specifically installed or nominated, following a suitable fire risk assessment);
- the safe use of and risks from storing or working with highly flammable and explosive substances; and
- the importance of general fire safety, which includes good housekeeping.

All the staff identified in your emergency plan that have a supervisory role if there is a fire (e.g. heads of department, fire marshals or wardens and, in complex premises, fire parties or teams), should be given details of your fire risk assessment and receive additional training.

Further guidance on training and how to carry out a fire drill is given in Part 2, Section 7.4.

### Checklist



- Have your staff received any fire safety training?
- Have you carried out a fire drill recently?
- Are employees aware of specific tasks if there is a fire?
- Are you maintaining a record of training sessions?
- Do you carry out joint training and fire drills in multi-occupied buildings?
- If you use or store hazardous or explosive substances have your staff received appropriate training?

## STEP 5 REVIEW

You should constantly monitor what you are doing to implement the fire risk assessment, to assess how effectively the risk is being controlled.



If you have any reason to suspect that your fire risk assessment is no longer valid or there has been a significant change in your premises that has affected your fire precautions, you will need to review your assessment and if necessary revise it. Reasons for review could include:

- changes to work activities or the way that you organise them, including the introduction of new equipment;
- alterations to the building, including the internal layout;
- substantial changes to furniture and fixings;
- the introduction, change of use or increase in the storage of hazardous substances;
- the failure of fire precautions, e.g. fire-detection systems and alarm systems, life safety sprinklers or ventilation systems;
- significant changes to type and quantities and/or method of storage of goods;
- a significant increase in the number of people present; and
- the presence of people with some form of disability.

You should consider the potential risk of any significant change before it is introduced. It is usually more effective to minimise a risk by, for example, ensuring adequate, appropriate storage space for an item before introducing it to your premises.

Do not amend your assessment for every trivial change, but if a change introduces new hazards you should consider them and, if significant, do whatever you need to do to keep the risks under control. In any case you should keep your assessment under review to make sure that the precautions are still working effectively. You may want to re-examine the fire prevention and protection measures at the same time as your health and safety assessment.

If a fire or 'near miss' occurs, this could indicate that your existing assessment may be inadequate and you should carry out a re-assessment. It is good practice to identify the cause of any incident and then review and, if necessary, revise your fire risk assessment in the light of this.

Records of testing, maintenance and training etc. are useful aids in a review process. See Appendix A1 for an example.

### **Alterations notices**

If you have been served with an 'alterations notice' check it to see whether you need to notify the enforcing authority about any changes you propose to make as a result of your review. If these changes include building work, you should also consult a building control body.

## **END OF PART 1**

You should now have completed the five-step fire risk assessment process, using the additional information in Part 2 where necessary. In any review you may need to revisit Steps 1 to 4.



# Part 2 Further guidance on fire risk assessment and fire precautions

## Managing fire safety

Good management of fire safety in your premises will help to ensure that any fire safety matters that arise are always effectively addressed.

In small factories and warehouses this can be achieved by the manager or owner maintaining and planning fire safety in conjunction with general health and safety.

In larger premises it is good practice for a senior manager to have overall responsibility for fire safety. It may be appropriate for this responsibility to be placed with the manager designated with overall responsibility for health and safety.

An organisation's fire safety policy should be flexible enough to allow modification. This is particularly important when local managers have to function daily with other businesses in the same building. It should be recognised that fire safety operates at all levels within an organisation and therefore local managers should be able to develop, where necessary, a local action plan for their premises.

The company policy should be set out in writing and may cover such things as:

- who will hold the responsibility for fire safety at board level;
- who will be the responsible person for each of their premises (this will be the person who has overall control, usually the manager);
- the arrangement whereby managers will, where necessary, nominate in writing specific people to carry out particular tasks if there is a fire; and
- the arrangement whereby regional or area managers should monitor and check that individual managers are meeting the requirements of the fire safety law.

You should have a plan of action to bring together all the features you have evaluated and noted from your fire risk assessment so that you can logically plan what needs to be done. It should not be confused with the emergency plan, which is a statement of what you will do if there is a fire.

The plan of action should include what you intend to do to reduce the hazards and risks you have identified and to implement the necessary protection measures.

You will need to prioritise these actions to ensure that any findings which identify people in immediate danger are dealt with straight away, e.g. unlocking fire exits. In other cases where people are not in immediate danger but action is still necessary, it may be acceptable to plan this over a period of time. Detailed recommendations are given in BS 5588-12.<sup>52</sup>

The guidance in Part 2 provides additional information to:

- ensure good fire safety management by helping you establish your fire prevention measures, fire precautions and fire safety procedures (systems equipment and plans); and
- assist you to carry out your fire safety risk assessment and identify any issues that need attention.

# Section 1 Further guidance on fire risks and preventative measures

This section provides further information on evaluating the risk of a fire and its prevention in your premises. You should spend time developing long-term workable and effective strategies to reduce hazards and the risk of a fire starting. At its simplest this means separating flammable materials from ignition sources.

You should consider:

- housekeeping;
- storage (including high fire loads and high rack storage);
- dangerous substances: storage, display and use;
- equipment and machinery;
- electrical safety;
- smoking;
- managing building work and alterations;
- existing layout and construction;
- particular hazards in corridors and stairways used as escape routes;
- insulated core panels;
- restricting the spread of fire and smoke;
- arson; and
- help for people with special needs.

## 1.1 Housekeeping

Good housekeeping can lower the chances of a fire starting, so the accumulation of combustible materials in premises should be monitored carefully. Good housekeeping is essential to reduce the chances of escape routes and fire doors being blocked or obstructed.

Waste material should be kept in suitable containers prior to removal from the premises. If bins, particularly wheeled bins, are used outside, they should be secured in a compound to prevent them being moved to a position next to the building and set on fire. Skips should never be placed against a building and should

normally be a minimum of 6m away from any part of the premises (see Figure 13).

If you generate a considerable quantity of combustible waste material then you may need to develop a formal plan to manage this effectively, e.g. in packing and unpacking areas.

In higher risk areas you need to make sure arrangements are in place for safe close down, e.g. checking all appliances are turned off and combustible waste has been removed.

*Figure 13: Bins under a stairway (courtesy of Cheshire fire and rescue service)*



## 1.2 Storage

Many of the materials found in your premises will be combustible. If your premises have inadequate or poorly managed storage areas then the risk of fire is likely to be increased (see Figure 14). The more combustible materials you store the greater the source of fuel for a fire. Poorly arranged high racked storage could prevent equipment such as sprinklers working effectively.

Combustible materials are not just those generally regarded as highly combustible, such as polystyrene, but all materials that will readily catch fire. Even non-combustible materials may present a fire hazard when packed in combustible materials. However, by carefully considering the type of material, the quantities kept and the storage arrangements, the risks can be significantly reduced.

Figure 14: An example of poor storage



The absence of adequate storage arrangements results in congestion on the factory floor or warehouse. This may lead to a concealed fire, restriction of access to the fire; fire extinguishers; alarm points and escape routes. Discarded packaging materials, e.g. polystyrene and cardboard, and even piles of wooden pallets can introduce severe fire hazards.

Poorly managed storage areas often become over-stocked or dumping areas for unwanted material. Do not pile combustible material against electrical equipment or heaters, even if turned off for the summer, and do not allow smoking in areas where combustible materials are stored.

To reduce the risk, store excess materials and stock in a dedicated storage area, such as a purpose-built detached building, a storeroom with fire separation from the rest of the factory, or a controlled space on the factory floor. Goods stored on the factory floor should be restricted to the minimum quantities essential for the flow of work. Finished goods should be removed promptly.

As well as considering the materials used in your premises you should also consider their form. For example, wood in the form of solid baulks of timber is not readily ignitable, but chopped wood or kindling is (similarly with paper). Cardboard stored flat would not present a high fire risk, but rolls of cardboard stored vertically present a vertical surface for fire to spread rapidly upwards, corrugated cardboard presents an even greater risk.

Your fire risk assessment should also consider any additional risk generated by seasonal changes such as increased volumes of goods at Christmas.

Consider the following to reduce these risks:

- ensure you have sufficient storage areas for your needs; and
- ensure storage areas are adequately controlled and monitored.

### Voids

Voids (including roof voids) should not be used for the storage of combustible material. Such voids should be sealed off or kept entirely open to allow easy access for inspection.

### Storage of raw materials

Raw materials can contain large quantities of highly combustible materials, such as fats and oils. If ignited these materials can burn readily with high rates of heat release. The storage arrangement of these materials should be carefully considered, to ensure these fuels are kept separated from potential ignition sources.

### Combustible waste and packaging

Some processes involve large quantities of combustible waste and packaging. The sighting, use and removal of these materials needs to be carefully managed to ensure that they can not come into contact with potential ignition sources, and do not cause obstructions.

### Outdoor storage

Your main risks associated with outdoor storage are outdoor fires preventing escape from the building or undetected fire spread to the building. Fires are most likely to start in waste material or dry undergrowth. Tarpaulin, jute and plastic sacks can readily burn too. Sparks, cigarettes and arson are the likely ignition sources.

To reduce these risks, ensure that:

- goods, materials, pallets and vehicles are sited in designated storage areas away from the building, fire exits, windows and boundary fences; and
- outdoor areas are kept tidy, by clearing waste and vegetation.

### Stacked goods and high stacked storage

In a fire, flames will tend to spread very rapidly and vertically through the stored goods to the top of the stack or racking and then spread laterally to all levels. When fires occur in these conditions they can spread extremely quickly, presenting greater life risk to occupants. (Experimental testing has shown that with boxes stored on a 10m high racking system, fires started in vertical flues frequently reached to top of the racking within two minutes.<sup>75</sup>)

Consider the following to reduce these risks:

- a minimum clear space of 1m, between stack and ceiling or lighting;
- aisle width of at least 2.5m, to restrict the spread of fire across an aisle;
- aisle with adequate access, to minimise collisions;
- a minimum clear space of 0.5m, between stored goods and the internal walls to provide access (e.g. for the fire and rescue service);
- separation and segregation of hazardous material, e.g. rubber tyres, plastic products, sugar and oil foodstuffs, combustible fibres, paper and paper products, hanging garments, carpeting, pesticides, flammable liquids and gases, reactive chemicals and flammable aerosols. Fire-resisting compartments should be used in certain circumstances;
- measures to ensure fire doors and fire shutters are not obstructed;
- storage arrangements that ensure clearance between stored goods and lighting is maintained;
- storage arrangements that ensure sprinkler heads are not shielded by the racking;
- control measures where large volumes of packaging materials, are required, e.g. goods inwards and despatch areas;
- sprinkler protection to control or extinguish a fire at an early stage;
- monitored automatic fire detection to ensure the early arrival of the fire and rescue service; and
- smoke ventilation to allow firefighters early and improved intervention to maintain visibility and reduce temperatures.

Some local acts may require the provision of sprinklers, automatic fire detection and smoke ventilation to reduce the risk.

### 1.3 Dangerous substances: storage, display and use

Specific precautions are required when handling and storing dangerous substances to minimise the possibility of an incident. Your supplier should be able to provide detailed advice on safe storage and handling; however, the following principles will help you reduce the risk from fire:

- substitute highly flammable substances and materials with less flammable ones;
- reduce the quantity of dangerous substances to the smallest reasonable amount necessary for running the business or organisation;
- correctly store dangerous substances, e.g. in a fire-resisting enclosure. All flammable liquids and gases should ideally be locked away, especially when the premises are unoccupied, to reduce the chance of them being used in an arson attack; and
- ensure that you and your employees are aware of the fire risk the dangerous substances present and the precautions necessary to avoid danger.

Additional general fire precautions may be needed to take account of the additional risks that may be posed by the storage and use of these substances.

Certain substances and materials are by their nature, highly flammable, oxidising or potentially explosive. These substances are controlled by other legislation in addition to fire safety law, in particular the Dangerous Substances and Explosive Atmospheres Regulations 2002<sup>7</sup> (also see the HSE's *Approved code of practice and guidance*<sup>8</sup>).

### Flammable liquids

Highly flammable liquids present a particularly high fire risk. For example, a leak from a container of flammable solvents, such as acetone, may produce large quantities of heavier-than-air flammable vapours. These can travel large distances, increasing the likelihood of their reaching a source of ignition well away from the original leak, such as a basement containing heating plant and/or electrical equipment on automatic timers.

Flammable liquids stored in plastic containers can be a particular problem if involved in fire because they readily melt, spilling their contents and fuelling rapid fire growth.

The risk is reduced by ensuring the storage and use of highly flammable liquids is carefully managed; that materials contaminated with solvent are properly disposed of and when not in use, they are safely stored. In the workroom, up to 50 litres may be stored in a fire-resisting cabinet or bin that will contain any leaks (see Figures 15 and 16). Quantities greater than 50 litres should be stored in a dedicated highly flammable liquids store. Further guidance on the storage of highly flammable liquids in containers is available from the HSE.<sup>49</sup>

Figure 15: A fire-resisting pedal bin for rags



Figure 16: A 50 litre flammable storage bin

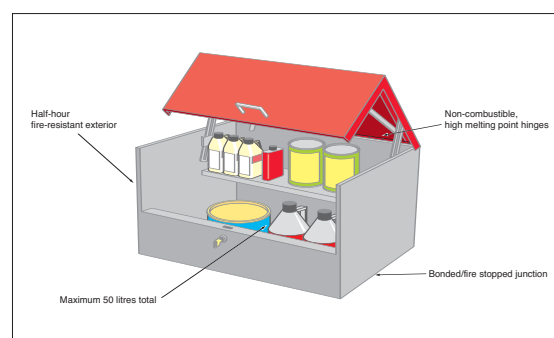

There should be no potential ignition sources in areas where flammable liquids are used or stored and flammable concentrations of vapours may be present. Any electrical equipment used in these areas, including fire alarm and emergency lighting systems, needs to be suitable for use in flammable atmospheres. In such situations, you should seek advice from a competent person.

### LPG storage and use

Where LPG in cylinders or cartridges is present, you need to take particular care to minimise the possibility of its involvement in a fire. The total amount of LPG in use should be kept to the minimum necessary to meet your needs: only that required for immediate use should be kept within the premises. The maximum stock should not exceed 70kg, which should be kept in a safe place, where it cannot be interfered with, and away from stairways, exit doors and places where it might obstruct means of escape.

Keep stored LPG cylinders, both full and empty, separate from other flammable and incompatible materials, in a safe and secure location, either in the open air or in a properly constructed and adequately ventilated storeroom.

Advice on the use of LPG for heating is given in Section 1.4.

Bulk storage tanks and bulk cylinder stores should be designed, installed and located in accordance with industry guidance.

Further guidance on the safe storage of LPG is available from your supplier or the Liquefied Petroleum Gas Association's Code of Practice.<sup>9</sup>

## Piping

Piping conveying gas or flammable liquid should be, as far as practicable, of rigid metal. Any necessary flexible piping should consist of material suitable for the gas or liquid being conveyed; it should be adequately reinforced to resist crushing and withstand the maximum internal pressure to which it may be subjected. Any connections to the flexible piping should be of an approved pattern (i.e. screwed or otherwise secured with a patent design device to prevent accidental disconnection). If in doubt you should seek advice from a competent person.

## Dust

Flammable dusts can initiate fire and explosions in factories and warehouses. Dust clouds can be formed by the release of powder (e.g. foodstuffs or chemicals). Release can occur by puncturing containers or in the act of transferring powders.

Preventative measures include:

- training in the handling of powders;
- correct use of handling equipment;
- ensuring that no potential ignition sources are taken into the dust cloud (e.g. fork lift trucks); and
- establishing procedures for cleaning up (e.g. vacuuming or wetting).

Where there are quantities of powder greater than 25kg a DSEAR<sup>8</sup> risk assessment will be required. Further guidance is available in the HSE guide<sup>76</sup> on handling of combustible dusts.

## Fireworks and explosives

Fireworks and explosives can cause fires and explosions in factories and warehouses. They have the potential for a violent release of pressure and heat that can cause severe harm to people and damage to a building.

These materials can be ignited or detonated by contact with ignition sources or by contamination, where other chemicals or water cause the material to become unstable.

Preventative measures include:

- excluding ignition sources;
- appropriate storage containers;

- training in the handling of fireworks and explosives; and
- establishing separation distances between explosive buildings and other buildings.

In most cases, where fireworks and explosives are manufactured or stored, a licence will be required under the Manufacture and Storage of Explosives Regulations 2005.<sup>50</sup> Further guidance is available on the HSE website [www.hse.gov.uk/explosives](http://www.hse.gov.uk/explosives) and in an HSE leaflet.<sup>51</sup>

## Aerosols

Some aerosol cans contain flammable products stored at pressure and can present a high level hazard. When ignited, they can explode, produce fireballs and rocket to distances of 40m. Their presence can make it unsafe for firefighters to enter a building and they have the potential for starting multiple fires.

In warehouse situations the main causes of aerosol can failure are: puncture by truckforks or sharp objects; being run over when loose on the floor; falls from a height, e.g. high racking; or bursting on heating.

The following should be considered to reduce these risks:

- All staff involved in the movement, storage and display of aerosol cans should be adequately instructed, trained and supervised.
- Damaged and leaking aerosol cans should be removed immediately to a safe, secure, well ventilated place prior to disposal. Powered vehicles should not be used to move damaged stock, unless specially adapted for use in flammable atmospheres. Arrangements should be made for its safe disposal at a licensed waste management facility.
- Segregation of stocks of aerosol cans from other items e.g. by the use of caging. For larger quantities of aerosol cans a fire-resisting enclosure should be used.
- Sprinkler protection.
- Cleaning and other staff should be made aware of the potential dangers of aerosol cans and the need for safe disposal.

Further guidance on handling of aerosols is available from the British Aerosol Manufacturers' Association.<sup>48</sup>



## 1.4 Equipment and machinery

Common causes of fire in equipment are:

- allowing ventilation points to become clogged or blocked, causing overheating;
- inadequate cleaning of heat-shrink packaging equipment;
- allowing excessive deposits to build up in fume and dust extraction equipment and associated ducting in catering environments;
- loose drive belts or lack of lubrication leading to increased friction;
- disabling or interfering with automatic or manual safety features and cut-outs;
- leaking valves, glands or joints allowing oils and other flammable liquids to contaminate adjacent floors or goods; and
- misuse or lack of maintenance of cooking equipment and appliances.

All machinery, equipment and plant should be properly maintained by a competent person. Appropriate signs and instructions on safe use may be necessary.

### Fork lift trucks and other vehicles

There are hazards associated with industrial vehicles, particularly during refuelling and maintenance operations; also when stored or in use.

Battery charging of fork lift trucks can give rise to sparks and hydrogen (a gas that is highly flammable, explosive and is lighter than air). Sparks can occur when connecting and disconnecting power supplies.

Fork lift truck charging points should be carefully sited in a well ventilated area (ideally direct to open air), clear of ignition sources and preferably in a separate dedicated non-combustible structure. However, if sited in the building, the charging point should be against a fire-resisting wall (e.g. 30-minute fire resistance).

### Heating

Individual heating appliances require particular care if they are to be used safely, particularly those which are kept for emergency use during a power cut or as supplementary heating during severe weather. The greatest risks arise from lack of maintenance and staff unfamiliarity with them. Heaters should be secured in position when in use and fitted with a fire guard if appropriate.

As a general rule, convector or fan heaters should be preferred to radiant heaters because they present a lower risk of fire and injury. The following rules should be observed:

- All heaters should be kept well clear of combustible materials and where they do not cause an obstruction.
- Heaters which burn a fuel should be sited away from draughts.
- Portable fuel burning heaters (including bottled gas (LPG)) should only be used in public areas in exceptional circumstances and if shown to be acceptable in your risk assessment.

All gas heating appliances should be used only in accordance with manufacturer's instructions and should be serviced annually by a competent person.

### Cooking processes

Typical installations used in cooking processes include: deep fat fryers, surface fryers, ovens, grills, surface cookers, smoking cabinets, ductwork, flues, filters, hoods, extract and ventilation ducts, and dampers.

These cooking processes can operate with high temperatures, involve large quantities of oil and combustible foodstuffs. Heat sources used for cooking processes include: gas, electric, microwave, radio frequency, and thermal fluids. The main causes of fire are ignition of cooking oil, combustion of crumbs and sediment deposits, and duct work fires from a build up of fats and grease.

The siting of cooking processes close to insulated core panels with combustible insulation (see Section 1.10) can lead to the likely ignition of the panels and consequent rapid fire spread to other parts of the building. This practice should therefore be avoided where possible.

The following should be considered to reduce the fire risk from cooking processes:

- regular cleaning to prevent build-up of crumbs and other combustible material;
- fire resisting containers for waste product;
- a fire suppression system capable of controlling an outbreak of fire;
- monitored heat/oil levels, even after the cooking process is complete, and installation of temperature control/cut-off/shut-off devices as appropriate;

- duct, joints and supports able to withstand high cooking temperatures;
- separation from wall and ceiling panels (with combustible insulation), e.g. 2.5m for walls, 4m for ceilings;
- insulation of ducts to prevent heating/igniting nearby combustible materials and wall/ceiling panels;
- a regular programme for inspection and cleaning;
- a programme of electrical and mechanical maintenance;
- an annual programme of thermographic surveys to identify 'hotspots';
- ovens in a single storey non-combustible building; and
- annual service of all gas heating appliances by a competent person.

#### Other equipment

Electrical refrigeration defrost systems can raise electrical heating coils built inside the refrigerator to 600°C, introducing an ignition source. Measures to reduce the fire risk include temperature probes and cut-offs.

Spray driers for converting liquids to powders and other dried products can produce fire and explosion hazards by ignition of the powders and dusts or by spontaneous combustion. Measures to reduce the fire risk include regular removal of dust deposits, explosion venting, automatic suppression systems, and electrical safety including grounding and bonding.

Conveyor systems can provide an ignition source, by heating due to friction, bearing seizure and static charge. Conveyors often penetrate walls and occasionally ceilings and can compromise fire separation. Hydraulic conveyors can significantly increase the fuel load. Measures to reduce the fire risk include: regular maintenance of belts and drive motors, monitoring of bearing temperature and belt slip, bespoke conveyor closure devices and automatic suppression systems.

## 1.5 Electrical safety

Electrical equipment is a significant cause of accidental fires in factories and warehouses. The main causes are:

- overheating cables and equipment, e.g. due to overloading circuits, bunched or coiled cables or impaired cooling fans;
- incorrect installation or use of equipment;
- little or no maintenance and testing of equipment;
- damaged or inadequate insulation on cables or wiring;
- combustible materials being placed too close to electrical equipment, which may give off heat even when operating normally, or may become hot due to a fault;
- arcing or sparking by electrical equipment;
- embrittlement and cracking of cable sheathing in cold environments;
- bunched cables passing through insulation which can generate excessive heat; and
- impaired cooling fans.

All electrical equipment should be installed and maintained in a safe manner by a competent person. If portable electrical equipment is used, including items brought into a workplace by staff, then your fire risk assessment should ensure that it is visually inspected and undergoes portable appliance testing ('PAT') at intervals suitable for the type of equipment and its frequency of use (refer to HSE guidance<sup>10</sup>). If you have any doubt about the safety of your electrical installation then you should consult a competent electrician.

Issues to consider include:

- overloading of equipment;
- correct fuse ratings;
- PAT testing and testing of the fixed installation;
- protection against overloading of installation;
- protection against short circuit;
- insulation, earthing and electrical isolation requirements;
- frequency of electrical inspection and test;

- temperature rating and mechanical strength of flexible cables;
- portable electrical equipment;
- physical environment in which the equipment is used (e.g. wet or dusty atmospheres); and
- use and maintenance of suitable personal protective equipment.

All electrical installations should be regularly maintained by a competent person, appointed by you, or on your behalf, in accordance with the Electricity at Work Regulations 1989 (EAW Regulations).<sup>53</sup> The use of low voltage equipment should conform to the requirements of the Electrical Equipment (Safety) Regulations 1994,<sup>54</sup> including the requirement to be CE marked.

## 1.6 Smoking

Carelessly discarded cigarettes and other smoking materials are a major cause of fire. A cigarette can smoulder for several hours, especially when surrounded by combustible material. Many fires are started several hours after the smoking materials have been emptied into waste bags and left for future disposal.

Consider operating a safe smoking policy in designated smoking areas and prohibit smoking elsewhere. Display suitable signs throughout the premises informing people of the smoking policy and the locations where smoking is permitted.

In those areas where smoking is permitted, provide deep and substantial metal ashtrays to help prevent unsuitable containers being used. Empty all ashtrays daily into a metal waste bin and take it outside. It is dangerous to empty ashtrays into plastic waste sacks which are then left inside for disposal later.

## 1.7 Managing building work and alterations

Fires are more frequent when buildings are undergoing refurbishment or alteration.

You should ensure that, before any building work starts, you have reviewed the fire risk assessment and considered what additional dangers are likely to be introduced. You will need to evaluate the additional risks to people,

particularly in those buildings that continue to be occupied. Lack of pre-planning can lead to haphazard co-ordination of fire safety measures.

You should liaise and exchange information with contractors who will also have a duty under the Construction (Health, Safety and Welfare) Regulations 1996<sup>11, 12</sup> to carry out a risk assessment and inform you of their significant findings and the preventive measures they may employ. This may be supported by the contractors' agreed work method statement. The designer should also have considered fire safety as part of the Construction (Design and Management) Regulations 1994 (the CDM Regulations).<sup>55</sup>

You should continuously monitor the impact of the building work on the general fire safety precautions, such as the increased risk from quantities of combustible materials and accumulated waste and maintaining adequate means of escape. You should only allow the minimum materials necessary for the work in hand within or adjacent to your building.

Activities involving hot work such as welding, flame cutting, use of blow lamps or portable grinding equipment can pose a serious fire hazard and need to be strictly controlled when carried out in areas near flammable materials. This can be done by having a written permit to work for the people involved (whether they are your employees or those of the contractor).

The purpose of the permit is to ensure that the area is made as safe as possible before any hot working starts, that monitoring and precautions continue to be taken whilst the work is in progress, and that the area where the hot work was carried out and the surrounding area are monitored for at least an hour after completion of the work.

A permit to work is appropriate in situations of high hazard/risk and, for example, where there is a need to:

- ensure that there is a formal check confirming that a safe system of work is being followed;
- co-ordinate with other people or activities;
- provide time limits when it is safe to carry out the work; and
- provide specialised personal protective equipment (such as breathing apparatus) or methods of communication.

Additional risks that can occur during building work include:

- temporary electrical equipment;
- blocking of escape routes including external escape routes;
- introduction of combustibles into an escape route;
- loss of normal storage facilities;
- fire safety equipment, such as automatic fire-detection systems becoming affected;
- fire-resisting partitions being breached or fire doors being wedged open (see Appendix B1 for information on fire-resisting separation); and
- additional personnel who may be unfamiliar with the premises.

You must notify the fire and rescue service about alterations in your premises if an alterations notice is in force (see who enforces the Fire Safety Order on page 7).

Further guidance on fire safety during construction work is available from the HSE<sup>56,57</sup> and the Fire Protection Association.<sup>58</sup>

## 1.8 Existing layout and construction

In warehouses the design is open-plan with large floor areas, e.g. large warehouse and distribution centres typically exceed 2,000m<sup>2</sup> and are often in excess of 20,000m<sup>2</sup>. The floor can be densely packed with stacked goods or high-bay racking systems. Factories, too, are often open-plan with designated process areas and storage areas, which can be located in separate rooms.

These buildings may include a number of open grate mezzanine floors and gallery levels. Often there are few windows and doors, except for access and escape.

Traditionally, occupants are advised to shut doors when escaping from a fire but in open-plan areas this may not be possible. In these areas the fire, and especially the smoke, may spread faster than expected.

To assess the risk in your premises you need to evaluate the construction and layout of your building. This does not mean a structural survey, unless you suspect that the structure is damaged or any structural fire protection is missing or damaged, but rather an informed

look around to see if there are any easy paths through which smoke and fire may spread and what you can do to stop that. In general, older buildings will have more void areas, possibly hidden from view, which will allow smoke and fire to spread away from its source. Whatever your type of building, you may need to consider typical situations that may assist the spread of fire and smoke such as:

- vertical shafts, e.g. lifts, open stairways, dumb waiters or holes for moving stock around;
- false ceilings, especially if they are not fire-stopped above walls;
- voids behind wall panelling;
- large roof cavities, particularly in cold stores;
- unsealed holes in walls and ceilings where pipe work, cables or other services have been installed; and
- doors, particularly to stairways, which are ill-fitting or routinely left open.

## 1.9 Particular hazards in corridors and stairways used as escape routes

Items that are a source of fuel, pose an ignition risk, or are combustible and likely to increase the fire loading or spread of fire, should not be located on any corridor or stairway that will be used as an escape route. Such items include:

- portable heaters, e.g. bottled gas (LPG) or electric radiant heaters and electric convectors or boilers;
- gas cylinders for supplying heaters;
- cooking appliances; and
- unenclosed gas pipes, meters, and other fittings.

However, depending on the findings of your risk assessment and where more than one escape route is available, items such as those below may be acceptable if the minimum exit widths are maintained and the item presents a relatively low fire risk:

- non-combustible lockers;
- vending machines;
- small items of electrical equipment (e.g. photocopiers); and
- small coat racks and/or small quantities of upholstered furniture which meets BS 7176 or the Furniture and Furnishings (Fire) (Safety) Regulations 1988.

## 1.10 Insulated core panels

Many buildings have insulated core panels as exterior cladding or for internal structures and partitions. The food industry, in particular, uses insulated core panels because they are easy to clean and facilitate consistent temperature control within the premises. The simple construction of these panels enables alterations and for additional internal partitions to be erected with minimum disruption to business.

They normally consist of a central insulated core, sandwiched between an inner and outer metal skin (see Figure 17). There is no air gap. The external surface is then normally coated with a PVC covering to improve weather resistance or the aesthetic appeal of the panel. The central core can be made of various insulating materials, ranging from virtually non-combustible through to highly combustible. Differing fire hazards are associated with common types of insulation, when the panels are subjected to certain temperatures. Typical examples are:

- Mineral rock/modified phenolic will produce surface char and little smoke or gaseous combustion products, at temperatures above 230°C.
- Polyisocyanurate (PIR)/polyurethane (PUR) will char and will generate smoke and gaseous combustion products, at temperatures above 430°C PIR and 300°C PUR.
- Expanded polystyrene (EPS) will melt and will generate smoke and gaseous combustion products, at temperatures above 430°C PIR.

Insulation charring can lead to panel delamination/collapse, and the gaseous combustion products can fill areas with the toxic gases carbon monoxide and styrene.

Figure 17: Insulated core panels – internal panel



A number of fires in buildings where insulated core panels have been used extensively in the fabric of the building have highlighted the particular dangers that may be associated with this form of construction, i.e. where the fabric of the building can contribute to the fire hazard.

In a fire the following may occur:

- early buckling and falling away of the facing materials;
- burning of the combustible insulating material;
- production of large quantities of dense, toxic smoke;
- rapid heat generation;
- early loss of structural strength can result if the system has not been properly designed, and this can lead to the collapse of the wall, partition or ceiling;
- there may be cavities in older buildings where the panels are used as an internal envelope, enabling fire to spread unnoticed and possibly unchecked by fire barriers.

Once installed it is difficult to identify the core material of a panel and its potential fire hazard.

The following best practice can help you reduce risks associated with insulated panels.

- Do not install heating appliances, such as baking ovens, against the panels. Operate a clear distance policy for cooking systems.
- Control ignition sources that are adjacent to, or penetrating the panels.
- Control hot working.
- Check for damage to heater tapes used to prevent ice build-up at doors.
- Do not store highly combustible materials against panels or allow rubbish to collect against panels.
- Have damaged panels or sealed joints repaired immediately and make sure that jointing compounds or gaskets used around the edges of the panels are in good order.
- Check where openings have been made for doors, windows, cables and ducts to ensure that these have been effectively sealed and the inner core has not been exposed.
- Check that there has been no mechanical damage and repair any that has occurred, e.g. caused by mobile equipment such as fork lift trucks.

- Ensure that any loads, such as storage and equipment, are only supported by panels that have been designed and installed to perform this function.
- Check that the inner and outer skins are adhering tightly to the core.
- Ensure that the panels are correctly secured to the structure or are designed to be independently structurally secure. One solution is to ensure the retaining brackets bolt the panel to a support frame through the outer and inner skins.
- Ensure large roof cavities are appropriately protected, e.g. escape routes are clear, signed and have limited travel distance, and fire warning systems are audible.

The use of combustible panels in areas of buildings with a high life risk, e.g. where large numbers of people are present, should be carefully considered. Your fire risk assessment may need to be revised to ensure that any increased risk resulting from this type of construction is considered.

The potential for fire development involving mineral fibre cores is less than that for panels containing polymeric cores. Therefore, in areas where there is considerable life risk, it may be appropriate to consider replacing combustible panels, providing a fire suppression system or installing non-combustible fire breaks within or between the panels at suitable intervals.

Insulated core panels should be installed by a competent person in accordance with industry guidance.

Guidance on the design, construction, specification and fire management of insulated core panels has been published by the International Association for Cold Storage Construction.<sup>59</sup>

## 1.11 Restricting the spread of fire and smoke

To reduce the risk to people if there is a fire, you need to consider how to control or restrict the spread of fire and smoke. The majority of people who die in fires are overcome by the smoke and gases.

### Roofs

Where the roofs of buildings are close together or connected to each other, flame or smoke can easily spread. This risk may be reduced by

fire prevention measures, or by fire separation. For some roof configurations, venting systems may offer a means of reducing the spread of fire (including the movement of flames under the roof) and the spread of smoke and toxic gases. Specialist advice should be sought on whether venting systems would be advantageous in a particular case. Where a roof contains combustible materials these should be replaced by non-combustible materials; where this is not practicable, the roof should be underdrawn with non-combustible board.

### Catering facilities

Wherever possible, any extensive catering facilities, particularly those with deep fat fryers, should be located in separate buildings. If located within other buildings they should be separated from the rest of the building by fire-resisting construction and provided with adequate ventilation. Where flues pass through any part of the structure, the structure should be protected by fire-resisting construction and the flue should terminate at a point where emissions can disperse in the open air. Where fire shutters are used these should be capable of operating both manually and by fusible link. Where a fire detection and warning system is installed, the fire shutter should also be designed to close on the activation of the system. Any automatic shutter should operate via a controlled geared mechanism.

### Display materials and decorations

You should evaluate what material could ignite first and what would cause the fire to develop and spread, and assess how materials used in temporary or permanent displays would interact with surface linings and position them accordingly. In particular, displays such as paper, textiles or other flimsy materials should not be located in stairways or corridors. However, such materials may be acceptable in other locations if treated with an appropriate fire-retardant product.

Staff information should be confined to appropriately located display boards in areas away from escape routes. Display boards may be used on escape routes as long as they are no bigger than 1m<sup>2</sup> or have been enclosed in a sealed display case.

### Fire-resisting structures

Many buildings are divided into different areas by fire doors and fire-resisting walls and floors. These are partly designed to keep a fire within one area, giving people more time to escape. You will need to identify which doors, walls and floors in your building are fire-resisting.

There may be information available from when the building was built, if alterations have been made, or from a previously held fire certificate.

High-risk areas (e.g. spray shops with highly flammable materials) should be separated from the rest of the premises by 30-minute fire-resisting construction.

Normally if there are fire doors in a wall, then the wall itself will also need to be fire-resisting (see Appendix B1 for more technical information about fire-resisting walls and doors). If a wall or floor is required to be fire-resisting then you should not make any holes in it, e.g. for extra doors or pipe ducts, without consulting a competent person.

To ensure effective protection against fire, walls and floors (including any openings such as doors, ventilation ducts, pipe passages or refuse chutes) providing fire separation must form a complete fire-resisting barrier.

The passing of services such as heating pipes or electrical cables through fire-resisting walls or partitions may leave gaps through which fire and smoke may spread. These should be rectified by suitable fire stopping and there are many proprietary products available for this purpose to suit particular types of construction. Such products should be installed by competent contractors.

### Smoke control

In some premises, there may be some form of smoke control provided for the safety of the occupants and to assist firefighting (e.g. Smoke and Heat Exhaust Ventilation Systems (SHEVS)). These systems are designed to restrict the spread of fire and smoke usually by venting the heat and smoke through the roof or via other routes to the outside. Low level inlet air is essential for the operation of SHEVS and all openings for this purpose should not be obstructed.

Special down-stands may have been installed to create a reservoir which will contain the smoke and hot gases at roof level, while vents allow the smoke to escape.

It is important that any smoke can flow easily into the reservoirs and that nothing which could cause an obstruction, such as large displays, is fixed near the vents.

If your building has smoke vents fitted, or any other form of smoke control, then you may need to seek advice from someone who is competent in such systems. Further information

on smoke control can be found from CIBSE Guide E<sup>64</sup> or from the BRE.<sup>65</sup>

### Sprinklers

In some premises there may be a sprinkler system. Sprinkler systems are designed to restrict the spread of fire by suppressing the fire. Further guidance is available in Part 2, Section 3.2.

## 1.12 Arson

Recent studies indicate that, across all premises types, over 2,100 deliberately set fires, resulting in two deaths and 55 injuries, occur every week. All premises can be targeted either deliberately or just because they offer easy access.

Be aware of other small, deliberately set fires in the locality, which can indicate an increased risk to your premises. Be suspicious of any small 'accidental' fires on the premises and investigate them fully and record your findings.

Fires started deliberately can be particularly dangerous because they generally develop much faster and may be intentionally started in escape routes. Of all the risk-reduction measures, the most benefit may come from efforts to reduce the threat from arson.

Measures to reduce arson may include the following:

- ensure the outside of the premises is well lit and, if practical, secure the perimeter of the premises;
- thoroughly secure all entry points to the premises, including windows and the roof, but make sure that this does not compromise people's ability to use the escape routes;
- make sure you regularly remove all combustible rubbish;
- do not place rubbish skips adjacent to the building and secure waste bins in a compound separated from the building;
- encourage staff to report people acting suspiciously;
- remove automatic entry rights from staff who have been dismissed;
- ensure that your security alarm/fire-detection system is monitored and acted on;
- secure flammable liquids so that intruders cannot use them;

- secure all storage areas and unused areas of the building that do not form part of an escape route against unauthorised access, ensure access to keys to those areas is restricted;
- fit secure metal letterboxes on the inside of letter flaps to contain any burning materials that may be pushed through; and
- do not park vehicles or store goods or materials in the open next to windows or doors opening into buildings.

Further guidance on reducing the risk of arson has been published by the Arson Prevention Bureau.\*

### 1.13 Help for people with special needs

Of all the people who may be especially at risk you will need to pay particular attention to people who have special needs, including those with a disability. The Disability Rights Commission estimates that 11 million people in this country have some form of disability, which may mean that they find it more difficult to leave a building if there is a fire. Under the Disability Discrimination Act,<sup>13</sup> if disabled people could realistically expect to use premises, then you must anticipate any reasonable adjustments that would make it easier for that right to be exercised.

The Disability Discrimination Act<sup>13</sup> includes the concept of 'reasonable adjustments' and this can be carried over into fire safety law. It can mean different things in different circumstances. For a small business it may be considered reasonable to provide contrasting colours on a handrail to help people with vision impairment to follow an escape route more easily. However, it might be unreasonable to expect that same business to install an expensive voice-alarm system. Appropriate 'reasonable adjustments' for a large business or organisation may be much more significant.

If disabled people are going to be in your premises then you must also provide a safe means for them to leave if there is a fire. You and your staff should be aware that disabled people may not react, or can react differently,

to a fire warning or a fire. You should give similar consideration to others with special needs such as parents with young children or the elderly.

In premises with a simple layout, a common-sense approach, such as offering to help lead a blind person or helping an elderly person down steps may be enough. In more complex premises, more elaborate plans and procedures will be needed, with trained staff assigned to specified duties.

Consider the needs of people with mental disabilities or spatial recognition problems. The range of disabilities encountered can be considerable, extending from mild epilepsy to complete disorientation in an emergency situation. Many of these can be addressed by properly trained staff, discreet and empathetic use of the 'buddy system' or by careful planning of colour and texture to identify escape routes.

Where people with special needs use or work in the premises, their needs should, so far as is practicable be discussed with them. These will often be modest and may require only changes or modifications to existing procedures. You may need to develop individual 'personal emergency evacuation plans' (PEEPs) for disabled persons who frequently use a building. They will need to be confident of any plan/PEEP that is put in place after consultation with them. As part of your consultation exercise you will need to consider the matter of personal dignity.

If members of the public use your building then you may need to develop a range of standard PEEPs which can be provided on request to a disabled person or others with special needs.

Guidance on removing barriers to the everyday needs of disabled people is in BS 8300.<sup>14</sup> Much of this advice will also help disabled people during an evacuation.

Further advice can be obtained from the Disability Rights Commission at [www.drc-gb.org](http://www.drc-gb.org).

\* Visit [www.arsonpreventionbureau.org.uk](http://www.arsonpreventionbureau.org.uk) for more information.



## Section 2 Further guidance on fire detection and warning systems

Where an electrical fire-warning system is necessary then a straightforward arrangement typically includes the following:

- manual call points (break-glass call points);
- electronic sirens or bells; and
- a control and indicator panel.

An alternative system of interconnected combined manual call points and sounders may be acceptable.

If your building has areas where a fire could develop undetected or where people work alone and might not see a fire, then it may be necessary to upgrade your fire-warning system to incorporate automatic fire detection.

If, for any reason, your system fails you must still ensure that people in your premises can be warned and escape safely. A temporary arrangement, such as gongs, whistles or air horns, combined with suitable training, may be acceptable for a short period pending system repairs.

The fire warning sound levels should be loud enough to alert everyone, taking into account background noise. In areas with high background noise, or where people may be wearing hearing protectors, the audible warning should be supplemented, e.g. with visual alarms.

### People with hearing difficulties

Where people have hearing difficulties, particularly those who are profoundly deaf, then simply hearing the fire warning is likely to be the major difficulty. If these persons are never alone while on the premises then this may not be a serious problem, as it would be reasonable for other occupants to let them know that the building should be evacuated. If a person with hearing difficulties is likely to be alone, then consider other means of raising the alarm. Among the most popular are visual beacons and vibrating devices or pagers that are linked to the existing fire alarm.

### Voice alarms

Research has shown that some people and, in particular, members of the public, do not always react quickly to a conventional fire alarm. Voice alarms are therefore becoming increasingly popular and can also incorporate a public address facility. The message or messages sent must be carefully considered. It is therefore essential to ensure that voice-alarm systems are designed and installed by a person with specialist knowledge of these systems.

### Schematic plan

In order to quickly determine where a fire has been detected, you should consider displaying a schematic plan showing fire alarm zones in a multi-zoned system adjacent to the control panel.

## 2.1 Manual call points

Manual call points, often known as 'break-glass' call points, enable a person who discovers a fire to immediately raise the alarm and warn other people in the premises of the danger.

People leaving a building because of a fire will normally leave by the way they entered. Consequently, manual call points are normally positioned, at exits and storey exits that people may reasonably be expected to use in case of fire, not just those designated as fire exits. However, it is not necessary in every case to provide call points at every exit.

Manual call points should normally be positioned so that, after all fixtures and fittings, machinery and stock are in place, no one should have to travel more than 45m to the nearest alarm point. This distance may be less if your premises cater for people of limited mobility or there are particularly hazardous areas. They should be conspicuous (red), fitted at a height of about 1.4m (or less for premises with a significant number of wheelchair users), and not in an area likely to be obstructed.

## 2.2 Automatic fire detection

Automatic fire detection may be needed for a number of reasons. These can include:

- if you have areas where people are isolated or remote and could become trapped by a fire because they are unaware of its development, such as lone workers;
- if you have areas where a fire can develop unobserved (e.g. storerooms);
- as a compensating feature, e.g. for inadequate structural fire protection, in dead-ends or where there are extended travel distances; and
- where smoke control and ventilation systems are controlled by the automatic fire-detection system.

If you have an automatic fire detection system, the system should:

- be designed to accommodate the emergency evacuation procedure;
- give an automatic indication of the fire warning and its location. If the indicator panel is located in a part of the premises other than the control point (for example, the secretary's office) there should ideally be a repeater panel sited in the control point;
- be maintained and tested by a competent person; and
- communicate with a central control room (if you have one).

New automatic fire detection systems should be designed and installed by a competent person. Further guidance is given in BS 5839-1<sup>16</sup> or a more recent standard where applicable.

Where the public address system is part of the fire warning system it should be connected to an auxiliary power source to ensure the continued use of the system in the event of fire or other emergency.

Whichever warning or detection systems are in place, the fire and rescue service should always be called immediately if a fire occurs.

## 2.3 Reducing false alarms

False alarms from automatic fire detection systems are a major problem and result in many unwanted calls to the fire and rescue service every year. Guidance on reducing false alarms has been published by ODPM/CFOA/BFPSA.<sup>15</sup>

If there are excessive false alarms in your premises, people may become complacent and not respond correctly to a warning of a real fire. In such circumstances, you may be failing to comply with fire safety law. All false alarms should be investigated to identify the cause of the problem and remedial action taken.

To help reduce the number of false alarms, the system design and location of detection and activation devices should be reviewed against the way the premises are currently used. For example, if a store room has been converted to a staff area with cooking facilities (e.g. a microwave and toaster) then the likelihood of the detector being set off is increased. Similarly, if a manual call point is placed in a storage area where there is continual movement of goods, the call point is likely to be accidentally damaged. In this case a simple, fabricated hinged metal guard around the call point is likely to solve the problem.

Occasionally people set off a manual call point in the genuine, but incorrect belief that there is a fire. Nothing should be done to discourage such actions and the number of false alarms generated this way is not significant.

Further detailed guidance on reducing false alarms is available in BS 5839-1.<sup>16</sup>

## 2.4 Staged fire alarms

In the vast majority of premises sounding the fire warning system should trigger the immediate and total evacuation of the building. However, in some large or complex premises this may not be necessary and alternative arrangements may be in place.

These alternative arrangements broadly fall into two groups. Firstly, those people potentially most at risk from a fire, usually those closest to where the alarm was activated, will be immediately evacuated, while others in the premises are given an alert signal and will only evacuate if it becomes necessary. This is generally called

a phased evacuation and the initial movement, depending on the layout and configuration of the premises, can be either horizontal or vertical.

The second alternative is for the initial alert signal to be given to certain staff, who then carry out pre-arranged actions to help others to evacuate more easily. It requires able, fully-trained staff to be available at all times and should not be seen as a simple means of reducing disruption to working practices. Where staged alarms are being used, disabled people should be alerted on the first stage to give them the maximum time to escape.

These arrangements both require fire-warning systems capable of giving staged alarms, including an 'alert signal' and a different 'evacuate signal' and should only be considered after consultation with specialist installers and, if necessary, the relevant enforcing authority.

Such systems also require a greater degree of management input to ensure that staff and others are familiar with the system and action required.

## 2.5 Testing and maintenance

Your fire-warning and/or detection system should be supervised by a named responsible person, who has been given enough authority and training to manage all aspects of the routine testing and scrutiny of the system.

The control and indicating equipment should be checked at least every 24 hours to ensure there are no specific faults. All types of fire-warning systems should be tested once a week. For electrical systems a manual call point should be activated (using a different call point for each successive test), usually by inserting a dedicated test key (see Figure 18). This will check that the control equipment is capable of receiving a signal and in turn, activating the warning alarms. Manual call points may be numbered to ensure they are sequentially tested.

Figure 18: Using a test key



Testing of the system should be carried out by a competent person. Further guidance on testing and maintenance of fire warning systems can be found in British Standards 5839-1.<sup>16</sup>

It is good practice to test the alarm at the same time each week, but additional tests may be required to ensure that staff or people present outside normal working hours are given the opportunity to hear the alarm.

Where systems are connected to a central monitoring station, arrangements should be made prior to testing to avoid unwanted false alarms.

Six-monthly servicing and preventive maintenance should be carried out by a competent person with specialist knowledge of fire-warning and automatic detection systems. This task is normally fulfilled by entering into a service contract with a specialist fire alarm company.

It is good practice to record all tests, false alarms and any maintenance carried out.

## **2.6 Guaranteed power supply**

If your fire risk assessment concludes that an electrical fire-warning system is necessary, then the Health and Safety (Safety Signs and Signals) Regulations 1996<sup>5</sup> requires it to have a back-up power supply.

Whatever back-up system is used, it should normally be capable of operating the fire-warning and detection system for a minimum period of 24 hours and sounding the alarm signal in all areas for 30 minutes.

## **2.7 New and altered systems**

Guidance on the design and installation of new systems and those undergoing substantial alterations is given in BS 5839-1.<sup>16</sup> If you are unsure that your existing system is adequate you will need to consult a competent person.

## Section 3 Further guidance on firefighting equipment and facilities

You have responsibility for the provision of appropriate firefighting equipment. It is also your responsibility to check that all firefighting equipment is in the correct position and in satisfactory order before the premises are used.

Appropriate staff should be trained in the use of all equipment.

### 3.1 Portable firefighting equipment

Fire extinguishers provided should be appropriate to the specific risks found in your premises in accordance with Table 1. This table also shows the different classes of fire, according to what is burning.

#### Number and type of extinguishers

Typically for the Class A fire risk, the provision of one water-based extinguisher for approximately every 200m<sup>2</sup> of floor space, with a minimum of two extinguishers per floor, will normally be adequate.

Where it is determined that there are additionally other classes of fire risk, the appropriate type, number and size of extinguisher should be provided. Further information is available in BS 5306-8.<sup>18</sup>

Where the fire risk is not confined to a particular location, e.g. Class A fires, the fire extinguishers should be positioned on escape routes, close to the exit from the room or floor, or the final exit from the building. Similarly, where the particular fire risk is specifically located, e.g. flammable liquids, the appropriate fire extinguisher should be near to the hazard, so located that they can be safely used. They should be placed on a dedicated stand or hung on a wall at a convenient height so that employees can easily lift them off (at about 1m for larger extinguishers, 1.5m for smaller ones, to the level of the handle). Ideally no one should have to travel more than 30m to reach a fire extinguisher. If there is a risk of malicious use you may need to use alternative, and more secure, locations.

Consider the implications of the Manual Handling Operations Regulations 1992<sup>17</sup> when selecting and siting firefighting equipment.

Table 1: Class of fire

Class of fire	Description
Class A	Fires involving solid materials such as wood, paper or textiles.
Class B	Fires involving flammable liquids such as petrol, diesel or oils.
Class C	Fires involving gases.
Class D	Fires involving metals.
Class F	Fires involving cooking oils such as deep-fat fryers.

#### Notes:

1. If there is a possibility of a fire in your premises involving material in the shaded boxes then you should seek advice from a competent person.
2. It is not safe to fight fires involving aerosols with fire extinguishers.

In self-contained small premises, multi-purpose extinguishers which can cover a range of risks may be appropriate. Depending on the outcome of your fire risk assessment, it may be possible to reduce this to one extinguisher in very small premises with a floor space of less than 90m<sup>2</sup>.

Extinguishers manufactured to current standards (BS EN 3-7<sup>78</sup>) are predominately red but may have a colour-coded area, sited above or within the instructions, denoting the type of extinguisher. Most older extinguishers, manufactured to previous standards, have bodies painted entirely in a single colour which denotes the type of extinguisher. These older extinguishers remain acceptable until they are no longer serviceable. However, it is good practice to ensure that old and new style extinguishers are not mixed on the same floor of a building.

The following paragraphs describe different types of extinguisher. The colour referred to is the colour of the extinguisher or the colour-coded area.

#### **Water extinguishers (red)**

This type of extinguisher can only be used on Class A fires. They allow the user to direct water onto a fire from a considerable distance. A 9-litre water extinguisher can be quite heavy and some water extinguishers with additives can achieve the same rating, although they are smaller and therefore considerably lighter. This type of extinguisher is not suitable for use on live electrical equipment.

#### **Water extinguishers with additives (red)**

This type of extinguisher is suitable for Class A fires. They can also be suitable for use on Class B fires and where appropriate, this will be indicated on the extinguisher. They are generally more efficient than conventional water extinguishers.

#### **Foam extinguishers (cream)**

This type of extinguisher can be used on Class A or B fires and is particularly suited to extinguishing liquid fires such as petrol and diesel. They should not be used on free-flowing liquid fires unless the operator has been specially trained, as these have the potential to rapidly spread the fire to adjacent material. This type of extinguisher is not suitable for deep-fat fryers or chip pans.

#### **Powder extinguishers (blue)**

This type of extinguisher can be used on most classes of fire and achieve a good 'knock down' of the fire. They can be used on fires involving electrical equipment but will almost certainly render that equipment useless. Because they do not cool the fire appreciably it can re-ignite. Powder extinguishers can create a loss of visibility and may affect people who have breathing problems and are not generally suitable for confined spaces.

#### **Carbon dioxide extinguishers (black)**

This type of extinguisher is particularly suitable for fires involving electrical equipment as they will extinguish a fire without causing any further damage (except in the case of some electronic equipment e.g. computers). As with all fires involving electrical equipment, the power should be disconnected if possible.

#### **Class 'F' extinguishers**

This type of extinguisher is particularly suitable for commercial catering establishments with deep-fat fryers.

#### **Selection, installation and maintenance of portable fire extinguishers**

All portable fire extinguishers will require periodic inspection, maintenance and testing. Depending on local conditions such as the likelihood of vandalism or the environment where extinguishers are located, carry out brief checks to ensure that they remain serviceable. In normal conditions a monthly check should be enough. Maintenance by a competent person should be carried out annually.

New fire extinguishers should comply with BS EN 3-7.<sup>78</sup> Guidance on the selection and installation of fire extinguishers is given in BS 5306-8,<sup>18</sup> for maintenance in BS 5306-3<sup>19</sup> and for colour coding in BS 7863.<sup>20</sup>

#### **Fire blankets**

Fire blankets should be located in the vicinity of the fire hazard they are to be used on, but in a position that can be safely accessed in the event of a fire. They are classified as either light duty or heavy duty. Light-duty fire blankets are suitable for dealing with small fires in containers of cooking oils or fats and fires involving clothing. Heavy-duty fire blankets are for industrial use where there is a need for the blankets to resist penetration by molten materials.

### 3.2 Fixed firefighting installations

These are firefighting systems which are normally installed within the structure of the building. They may already be provided in your premises or you may be considering them as a means of protecting some particularly dangerous or risk-critical areas as part of your risk-reduction strategy.

#### Hose reels

Permanent hose reels (see Figure 19) installed in accordance with the relevant British Standard (see BS EN 671-3: 2000<sup>21</sup>) provide an effective firefighting facility. They may offer an alternative, or be in addition to, portable firefighting equipment. A concern is that untrained people will stay and fight a fire when escape is the safest option. Where hose reels are installed, and your fire risk assessment expects relevant staff to use them in the initial stages of a fire, they should receive appropriate training.

**Note:** It is not safe to fight fires involving aerosols with hose reels.

Maintenance of hose reels includes visual checks for leaks and obvious damage and should be carried out regularly. More formal maintenance checks should be carried out at least annually by a competent person.

Figure 19: Hose reel



#### Sprinkler systems

Sprinkler systems can be very effective in controlling fires. They can be designed to protect life and/or property and may be regarded as a cost-effective solution for reducing the risks created by fire. If you have a sprinkler installation, it may have been installed as a result of a business decision, e.g. for the protection of business assets, or they may have been installed as a requirement, e.g. imposed under a local act, or an integral part of the building design.

Sprinkler systems should normally extend to the entire building. In a well designed system only those heads in the immediate vicinity of the fire will actually operate. Sprinkler installations typically comprise a water supply (preferably a stored water supply incorporating tanks), pumps, pipework and sprinkler heads. There are different types of sprinkler design; sprinklers can be operated to discharge water at roof or ceiling level or within storage racks. Other design types such as ESFR (early suppression fast response) and dry pipe may also be appropriate. In all cases a competent person/contractor should be used to provide guidance.

The installation should be designed for the fire hazard; taking into account the building occupancy, the fire load and its burning characteristics and the sprinkler control characteristics. For each hazard the sprinkler installation design should take account of specific matters such as: storage height, storage layout, ceiling clearance, and sprinkler type (e.g. sprinkler orifice, sprinkler sensitivity).

There are some hazards where sprinklers should not be fitted, such as over salt baths and metal melt pans, because water will possibly cause an explosive reaction.

If you are making significant changes to your premises, e.g. changing storage arrangements or material stored, you should check your sprinkler installation is still appropriate and seek expert advice as necessary.

Sprinkler protection could give additional benefits, such as a reduction in the amount of portable firefighting equipment necessary, and the relaxation of restrictions in the design of buildings.

Guidance on the design and installation of new sprinkler systems and the maintenance of all systems is given in the Loss Prevention Council (LPC) Rules, BS EN 12845<sup>22</sup> or BS 5306-2<sup>60</sup> and should only be carried out by a

competent person. Routine maintenance by on-site personnel may include checking of pressure gauges, alarm systems, water supplies, any anti-freezing devices and automatic booster pump(s). For example, diesel fire pumps should be given a test run for 30 minutes each week.

A competent maintenance contractor should provide guidance on what records need to be completed.

Following a sprinkler operation the sprinkler system should be reinstated by a competent person. A stock of spare sprinkler bulbs should be available on site for replacements, preferably in a separate building, e.g. the pump house.

If a sprinkler system forms an integral part of your fire strategy it is imperative that adequate management procedures are in place to cater for those periods when the sprinkler system is not functional. This should form part of your emergency plan. Although the actual procedures will vary, such measures may include the following:

- Restore the system to full working order as soon as possible.
- Limit any planned shutdown to low-risk periods when numbers of people are at a minimum (e.g. at night), or when the building is not in use. This is particularly important when sprinklers are installed to a life safety standard or form part of the fire safety engineering requirements.
- You may need to isolate the area without the benefit of working sprinklers from the rest of the premises by fire-resisting material.
- Avoid higher-risk processes such as 'hot-work'.
- Extra staff should be trained and dedicated to conducting fire patrols.
- Any phased or staged evacuation strategy may need to be suspended. Evacuation should be immediate and complete. (Exercise caution as the stairway widths may have been designed for phased evacuation only.)
- Inform the local fire and rescue service.

If, having considered all possible measures, the risk is still unacceptable then it will be necessary to close all or part of the building. If in doubt you should seek the advice of a competent person

### **Other fixed installations**

There are a number of other fixed installations including: local application water mist systems for fryer vats and hoods, local application gaseous systems for ducting and hoods, water deluge systems for rubbish compactors and fixed powder systems.

If your premises have a fixed firefighting system that you are unfamiliar with, then seek advice. Where a fixed firefighting system forms an integral part of your fire safety strategy, it should be maintained in accordance with the relevant British Standard by a competent person.

## **3.3 Other facilities (including those for firefighters)**

Building Regulations and other Acts, including local Acts, may have required firefighting equipment and other facilities to be provided for the safety of people in the building and to help firefighters. Fire safety law places a duty on you to maintain such facilities in good working order and at all times.

These may include:

- access for fire engines and firefighters;
- firefighting shafts and lifts;
- fire suppression systems, e.g. sprinklers, water mist and gaseous;
- smoke-control systems;
- dry or wet rising mains and firefighting inlets;
- information and communication arrangements, e.g. fire telephones and wireless systems and information to brief the fire and rescue service when they arrive; and
- firefighters' switches.

It may be appropriate to invite the fire and rescue service to familiarise themselves on products, layout and fire systems as a precautionary measure.

The Workplace (Health, Safety and Welfare) Regulations 1992<sup>23</sup> also require that systems provided for safety within a workplace are maintained.

### **Access for fire engines and firefighters**

Buildings that have been constructed to modern building regulations or in accordance with certain local Acts will have been provided with facilities that allow fire engines to approach



and park within a reasonable distance so that firefighters can use their equipment without too much difficulty.

These facilities may consist of access roads to the building, hard standing areas for fire engines and access into the building for firefighters. It is essential that where such facilities are provided they are properly maintained and available for use at all relevant times.

Where a building is used by a number of different occupants you will need to ensure co-operation between the various 'responsible people' to maintain fire and rescue service access. In exceptional cases, where access is persistently obstructed, you may need to make additional arrangements.

See Approved Document B to the Building Regulations<sup>24</sup> for more information.

### Firefighting shafts and lifts

Firefighting shafts (see Figure 20) are provided in larger buildings to help firefighters reach floors further away from the building's access point. They enable firefighting operations to start quickly and in comparative safety by providing a safe route from the point of entry to the floor where the fire has occurred.

Figure 20: Firefighting shaft

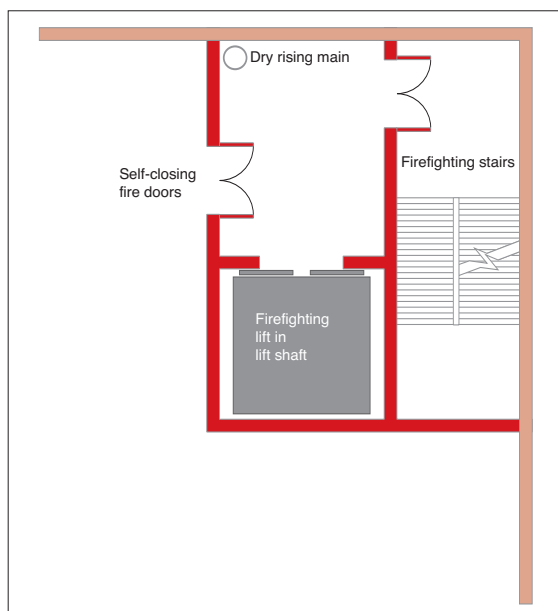

Entry points from a stairway in a firefighting shaft to a floor will be via a lobby, through two sets of fire and smoke-resisting doors and walls. Many people will use the stairway for normal movement through the building and

it is important that the safety features are not compromised by doors being wedged open.

Most firefighting shafts will also incorporate a firefighting lift which opens into the lobby. The lift will have a back-up electrical supply and car control overrides. The primary function of the lift is to transport firefighting personnel and their equipment to the scene of a fire with the minimum amount of time and effort. It may also be used to help evacuate less mobile people.

Alterations that might affect the shaft should not be made without first liaising with other responsible persons, any owners or managing agents and the enforcing authority. Any proposed changes will require Building Regulation approval from a Building Control Body.

Where a firefighting shaft is provided, it should be maintained by a competent person.

### Fire suppression systems

Fire suppression systems can include sprinklers and other types of fixed installations designed to automatically operate and suppress a fire. Such systems should be maintained by a competent person.

### Smoke control systems

These are complex systems that are provided for life safety of occupants, assistance to firefighters and property protection by clearing hot smoke and gases from the building. The smoke control system may have been a requirement, e.g. imposed under a local act, or an integral part of the building design.

If you have one of these systems provided in your premises you should ensure you understand how it operates and that it is maintained in full working order. If your system is part of a larger system then you should liaise with other occupiers and building managers.

The smoke control system should be maintained by a competent person who is familiar with the fire engineering performance specifications of that specific system. This is particularly important when the system is a requirement.

Where these systems are installed in addition to a sprinkler system then the design and installation of each system should not act detrimentally on one another. A competent person should be employed to confirm this.

Figure 21: Rising main

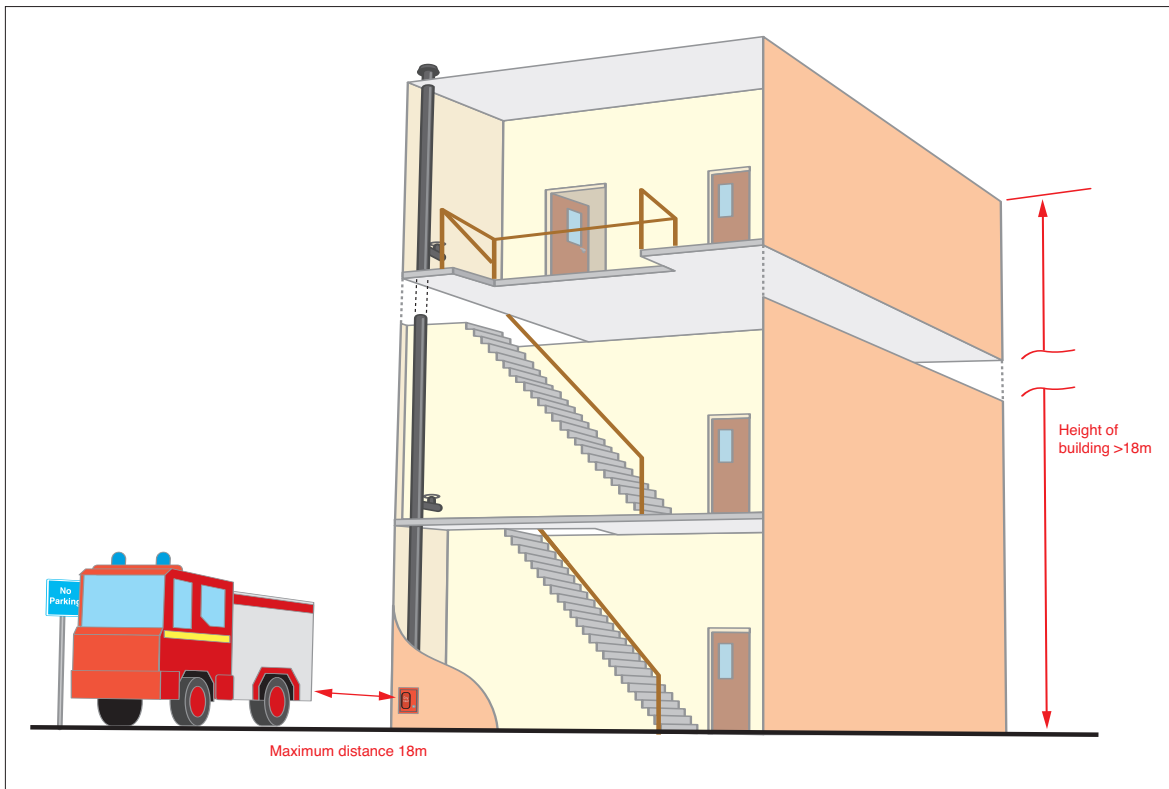

### Dry and wet rising fire mains

The rising fire main (see Figure 21) is an important facility for the fire and rescue service in taller buildings. It consists of an inlet box where firefighters can connect their hoses, a pipe running up or through the building, outlet valves on each floor level and an air vent at the top.

It is important that fire mains are kept in good working order. Issues to be considered can include the following:

- The physical approach to the inlet box should be such that a fire engine can park within 18m with the inlet box in view.
- Prohibit car parking in front of the inlet box.
- Secure the inlet box in such a way that firefighters can open the door without too much difficulty.
- It is advisable to lock the landing valves in the closed position, usually with a leather strap and padlock.

### Foam inlets

Foam inlets are special inlets usually fitted to provide an efficient way of extinguishing a fire in a basement or other area of high risk such as a plant room. In many respects they look

the same as rising main inlet boxes, but the door should be clearly marked 'foam inlet'. The risk area should be kept clear of obstructions to allow the foam to spread into the compartment.

### Maintenance of rising mains and foam inlets

All types of rising mains together with associated valves should be maintained and tested on a regular basis by a competent person. Guidance on inspection and testing of dry and wet rising mains is given in BS 5306-1. Although there are no recommended periods between maintenance checks for foam inlets it would be prudent to carry out an annual service.

### Firefighters' switches

Luminous discharge lighting is frequently used. Safety switches are normally provided to isolate high-voltage luminous signs or to cut off electrical power. In the case of existing installations, if they have been provided in accordance with previous legislation (e.g. the Local Government (Miscellaneous Provisions) Act 1982<sup>25</sup>), then it is likely that they will comply with the Order. If this is not the case, then you may need to consult the enforcing authority regarding the suitability of its location and marking. Testing should be carried out in accordance with the manufacturer's instructions. If you have no

such instructions then an initial test should be carried out by a competent electrician.

### **Other firefighting facilities**

As well as those already mentioned, other facilities to assist firefighters may have been installed in your premises and should be properly maintained by a competent person. Your maintenance audit (see Appendix A for an example checklist) should include these. Such facilities can include:

- information signs for firefighters;
- static water supplies, private hydrants, meter bypass valves and underground tanks;
- standby fire pumps, electrical generators, air pumps and hydraulic motors; and
- manual self-closing devices for roller shutter doors in fire compartment walls.

# Section 4 Further guidance on escape routes

## Introduction

This section provides further guidance on the general principles that apply to escape routes and provides examples of typical escape route solutions for a range of common building layouts. The guidance is based on premises of normal risk so if your premises (or part of your premises) are higher (or lower) risk you should adapt the solution accordingly.

You are not obliged to adopt any particular solution for escape routes in this section if you prefer to meet the relevant requirement in some other way. If you decide to adopt some alternative arrangement it will need to achieve at least an equivalent level of fire safety.

**Refer to the glossary (Appendix D) for the definitions of any terms you may not be familiar with.**

## Levels of risk

In order to apply the guidance in this section, you need to understand that in any fire situation, the time that people have to escape before they could become affected by the fire is limited. Providing them with sufficient time usually means that as well as having an appropriate way of detecting and giving warning in case of fire, the distance that people have to travel to make their escape to a place of reasonable or total safety must be restricted.

The travel distances which are usually appropriate for this purpose (and are suggested later in this section) vary according to the level of risk in the premises (or part of them). To check your escape routes you will need to form a judgement about the level of risk that people may be at after you have taken other risk reduction (preventative and protective) measures.

In premises where there is a likelihood of a fire starting and spreading quickly (or a fire could start and grow without being quickly detected and a warning given) and affect the escape routes before people are able to use them then the risk should normally be regarded as 'higher'. Such premises could include those where significant quantities of flammable materials are used or stored; ready

sources of ignition are present, e.g. heat producing machinery and processes; premises where significant numbers of the people present, are likely to move slowly or be unable to move without assistance; and premises where the construction provides hidden voids or flues through which a fire could quickly spread.

In premises where there is a low occupancy level and all the occupants are able bodied and capable of using the means of escape without assistance; very little chance of a fire; few if any highly combustible or flammable materials or other fuels for a fire; fire cannot spread quickly; and will be quickly detected so people will quickly know that a fire has occurred and can make their escape, then the risk can usually be regarded as 'lower'.

In most cases however, the risk will usually be 'normal'.

The travel distances suggested are not hard and fast rules and should be applied with a degree of flexibility according to the circumstances. For example, in premises where the risk might otherwise be considered 'normal' but where there are a significant number of people who move slowly or may need assistance to evacuate, it would usually be appropriate to consider this a 'higher' risk. However, where other measures are in place to mitigate this, such as the availability of extra assistance and this has been planned for in your emergency plan, it may be that the risk level can be regarded as 'normal to higher'.

Equally, in premises where the risk category would otherwise be 'lower' but for the fact that a small number of occupants may move slowly or need assistance, it may be appropriate to categorise the risk as 'normal' in these circumstances.

If you are not sure about the level of risk that remains in your premises, you should seek advice from a competent person.

## 4.1 General principles

### Suitability of escape routes

You should ensure that your escape routes are:

- suitable;
- easily, safely and immediately usable at all times;
- adequate for the number of people likely to use them;
- generally usable without passing through doors requiring a key or code to unlock, or with low level manual over-rides for metal roller shutter doors;
- free from any obstructions, slip or trip hazards;
- well lit by normal or emergency escape lighting; and
- available for access by the emergency services.

In multi-occupied premises, escape routes should normally be independent of other occupiers, i.e. people should not have to go through another occupier's premises as the route may be secured or obstructed. Where this is not possible, then robust legal agreements should be in place to ensure their availability at all times.

All doors on escape routes should open in the direction of escape and ideally be fitted with a safety vision panel. This is particularly important if more than 60 people are expected to use them at any one time or they provide an exit from an area of high fire risk.

At least two exits should be provided if a room/area is to be occupied by more than 60 persons. This number of 60 can be varied in proportion to the risk, for a lower risk there can be a slight increase, for a higher risk, lower numbers of persons should be allowed.

Movement of persons up or down a group of not less than three steps will be so obvious to those following that they will be prepared for the change in level, but movement up or down one step is not so readily observed and may easily lead to a fall. Wherever practicable, differences of level in corridors, passages and lobbies should be overcome by the provision of inclines or ramps of gradients not exceeding 1 in 12 or steps not having less than three risers in any flight. Corridors and passages should be level for a distance of 1.5 metres in each direction from any steps.

Any mirrors situated in escape routes should be sited so that persons escaping from a fire will not be thrown into confusion by any reflected image of the route they are using, or be misled as to the direction they should take to reach fire exits.

While not normally acceptable, the use of ladders, floor hatches, wall hatches or window exits may be suitable for small numbers of able-bodied, trained staff in exceptional circumstances.

### Fire-resisting construction

The type and age of construction are crucial factors to consider when assessing the adequacy of the existing escape routes. To ensure the safety of people it may be necessary to protect escape routes from the effects of a fire. In older premises (see Appendix C for more information on historical properties) it is possible that the type of construction and materials used may not perform to current fire standards. Also changes of occupancy and refurbishment may have led to:

- cavities and voids being created, allowing the potential for a fire to spread unseen;
- doors and hardware worn by age and movement being less likely to limit the spread of smoke;
- damaged or insufficient cavity barriers in modular construction; and
- breaches in fire compartment walls, floors and ceilings created by the installation of new services, e.g. computer cabling.

Where an escape route needs to be separated from the rest of the premises by fire-resisting construction, e.g. a dead-end corridor or protected stairway (see Figures 30 and 34 on pages 77 and 81, respectively), then you should ensure the following:

- Doors, (including access hatches to cupboards, ducts and vertical shafts linking floors), walls, floors and ceilings protecting escape routes should be capable of resisting the passage of smoke and fire for long enough so that people can escape from the building.
- Where suspended or false ceilings are provided, the fire resistance should extend up to the floor slab level above. For means of escape purposes a 30 minute fire-resisting rating is usually enough.
- Cavity barriers, fire stopping, and dampers in ducts are appropriately installed.

If there is any doubt about the nature of the construction of your premises, ask for advice from a competent person.

### Number of people using the premises

As your escape routes need to be adequate for the people likely to use them you will need to consider how many people, including employees and the public, may be present at any one time. Where premises have been subject to building regulations approval for use as either a factory or warehouse, the number and width of escape routes and exits will normally be enough for the anticipated number of people using the building. In such buildings where the risk has changed or buildings were constructed before national building regulations, it will be necessary to confirm the provision.

In most warehouses the number of people will be low, whilst in factories the numbers will vary depending on the facility. However, the maximum numbers of staff, visitors and contractors liable to be in the building at the same time will be known by the responsible person. There will also be an appreciation of the use of the building by those you know have special needs, such as the disabled.

If you propose to make changes to the use or layout of the building which may increase the number of people, you should check the design capacity by referring to guidance given in the Building Regulations Approved Document B.<sup>24</sup>

#### Case study

The activities in a warehouse change from packaging and distributing to a factory process involving a labour intensive manual assembly line. Before the introduction of the assembly line most of the floor area was used for storage of goods. Fewer staff were required in the warehouse and only a small number of fire exits were necessary. When the assembly line was introduced more staff were required. This necessitated checking the number and widths of exits, resulting in the need for an additional exit.

### Mobility impairment

Effective management arrangements need to be put in place for those who need help to escape.

Consider the following points:

- A refuge is a place of reasonable safety in which disabled people can wait either for an evacuation lift or for assistance up or down stairs (see Figure 22). Disabled people should not be left alone in a refuge area whilst waiting for assistance evacuate the building. Depending on the design and fire resistance of other elements, a refuge could be a lobby, corridor, part of a public area or stairway, or an open space such as a balcony or similar place which is sufficiently protected (or remote) from any fire risk and provided with its own means of escape and a means of communication.
- Where refuges are provided, they should be enclosed in a fire-resisting structure which creates a protected escape route which leads directly to a place of total safety and should only be used in conjunction with effective management rescue arrangements. Your fire safety strategy should not rely on the fire and rescue service rescuing people waiting in these refuges.
- If firefighting lifts (provided in high buildings as firefighting access) are to be used for evacuation, this should be co-ordinated with the fire and rescue service as part of the pre-planned evacuation procedures.
- Normal lifts may be considered suitable for fire evacuation purposes, subject to an adequate fire risk assessment and development of a suitable fire safety strategy by a competent person.
- Since evacuation lifts can fail, a disabled person, having reached a refuge, should also be able to gain access to a stairway (should conditions in the refuge become untenable). An evacuation lift with its associated refuge should therefore be located adjacent to a protected stairway.
- Sufficient escape routes should always be available for use by disabled people. This does not mean that every exit will need to be adapted. Staff should be aware of routes suitable for disabled people so that they can direct and help people accordingly.

- Stairways used for the emergency evacuation of disabled people should comply with the requirements for internal stairs in the building regulations. Specialist evacuation chairs or other equipment may be necessary to negotiate stairs.
- Plans should allow for the careful carrying of disabled people down stairs without their wheelchairs, should the wheelchair be too large or heavy. You will need to take into account Health and Safety manual handling procedures in addition to the dignity and confidence of the disabled person.
- Stairlifts should not be used for emergency evacuation. Where installed in a stairway used for emergency evacuation, no parts of the lift, such as its carriage rail, should be allowed to reduce the effective width of the stairway or any other part of an emergency evacuation route.
- Where ramps are necessary for the emergency evacuation of people in wheelchairs they should be as gentle as possible. Guidance is given in Approved Document M.<sup>62</sup>

Further guidance is available in BS 5588-8<sup>63</sup> and BS 5588-12.<sup>52</sup>

Figure 22: An example of a refuge

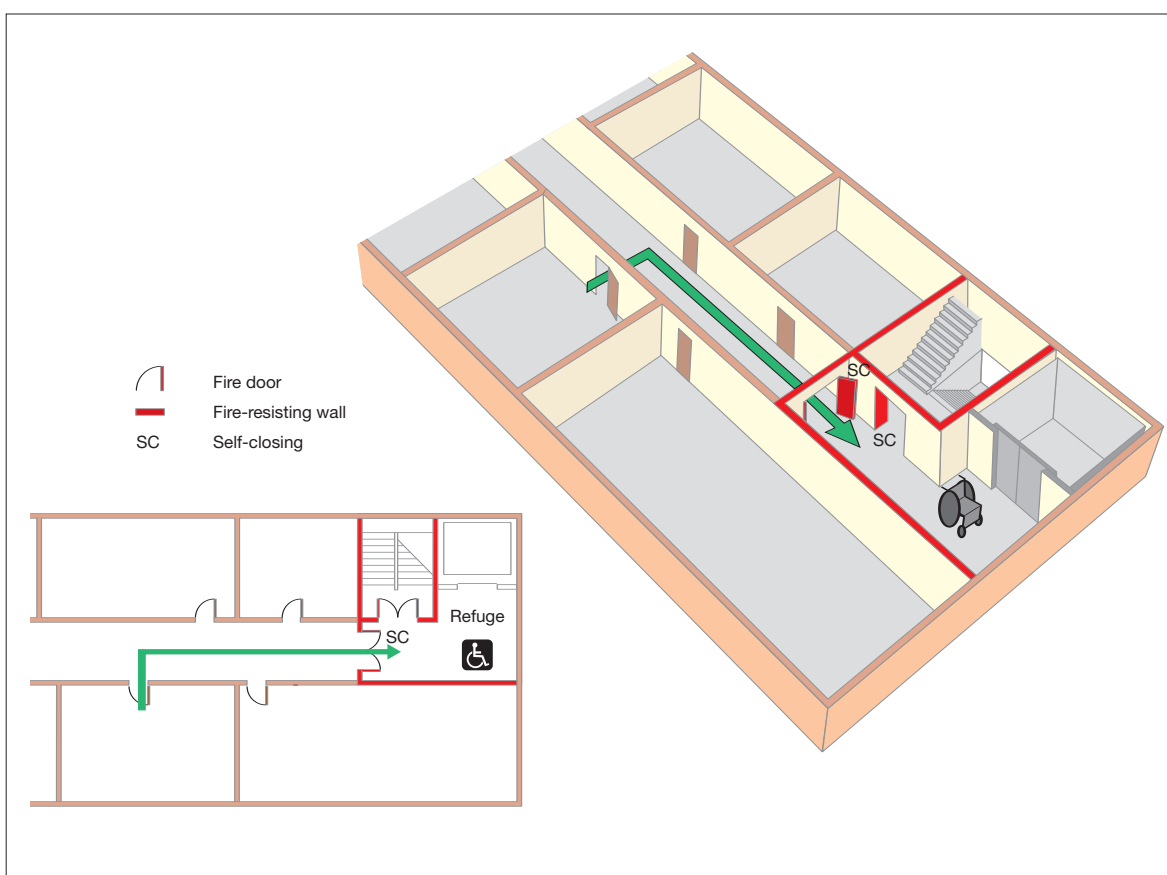

## Widths and capacity of escape routes and stairways

Once you have established the maximum number of people likely to be in any part of the premises, the next step is to establish that the capacity of the escape routes is adequate for people to escape safely and in sufficient time to ensure their safety in case of fire.

The capacity of a route is determined by a number of factors including the width of the route, the time available for escape and the ability of the people using them.

The effective usable width of an escape route is the narrowest point, normally a door or other restriction such as narrowing of a corridor due to fixtures and fittings. The capacity of an escape route is measured by the number of persons per minute that can pass through it so, to establish the capacity of the route, it is first necessary to measure the width of the route at the narrowest point. The effective width of a doorway is the clear unobstructed width through the doorway when the door is open at right angles to the frame. The effective width at any other point is the narrowest clear unobstructed width through which people can pass.

The time available for escape depends on several factors. Studies of human behaviour in an emergency situation have shown that about two thirds of the time available to escape is taken up by the initial reaction to the developing situation. For example, people will decide whether the situation is real or false, often waiting to see the reaction of people around them, and generally gathering information to decide whether to act or not. The final third is taken up by the actual movement away from the area of the fire. Throughout this time the fire may be growing and spreading. Therefore, to account for the limited time available for people to travel to a place of reasonable safety, the length of escape routes needs to be limited. The suggested travel distances in this section (Table 2) take this limitation into account.

The following guide can be used to determine the general capacities of escape routes:

A width of at least 750mm can accommodate up to:

- 80 people in higher risk premises;
- 100 people in normal risk premises; or
- 120 people in lower risk premises.

A width of at least 1,050mm can accommodate up to:

- 160 people in higher risk premises;
- 200 people in normal risk premises; or
- 240 people in lower risk premises.

An additional 75mm should be allowed for each additional 15 persons (or part of 15).

The minimum width of an escape route should not be less than 750mm (unless it is for use by less than five people in part of your premises) and, where wheelchair users are likely to use it, 900mm.

The aggregate width of all the escape routes should be not less than that required to accommodate the maximum number of people likely to use them.

When calculating the overall available escape route capacity for premises that have more than one way out, you should normally assume that the widest is not available because it has been compromised by fire. If doors or other exits leading to escape routes are too close to one another you should consider whether the fire could affect both at the same time. If that is the case, it may be necessary to discount them both from your calculation.

As a general rule stairways should be at least 1,050mm wide and in any case not less than the width of the escape routes that lead to them. In all cases the aggregate capacity of the stairways should be sufficient for the number of people likely to have to use them in case of fire.

Stairways wider than 2,100mm should normally be divided into sections, each separated from the adjacent section by a handrail, so that each section measured between the handrails is not less than 1,050mm wide.



### Travel distance

Having established the number and location of people and the exit capacity required to evacuate them safely, you now need to confirm that the number and location of existing exits is adequate. This is normally determined by the distance people have to travel to reach them.

Table 2 gives guidance on travel distances. It should be understood, however, that these distances are flexible and may be increased or decreased depending upon the level of risk after you have put in place the appropriate fire-prevention measures (Part 1, Step 3.3). For instance, some warehouse buildings that were designed with fire-engineered solutions may have extended travel distances.

In new buildings which have been designed and constructed in accordance with modern building standards the travel distances will

already have been calculated. Once you have completed your fire risk assessment you need to confirm that those distances are still relevant.

When assessing travel distances you need to consider the distance to be travelled by people when escaping allowing for walking around equipment, plant storage units, etc. The distance should be measured from all parts of the premises to the nearest place of reasonable safety which is:

- a protected stairway enclosure (a storey exit);
- a separate fire compartment from which there is a final exit to a place of total safety; or
- the nearest available final exit.

The suggested travel distances may be increased by the addition of further fire protection measures, e.g. automatic fire detection.

Table 2: Suggested travel distances

Escape routes	Suggested range of travel distance
Where more than one escape route is provided	25m in higher fire-risk area <sup>1,2</sup> 45m in normal fire-risk area 60m in lower fire-risk area <sup>3</sup>
Where only a single escape route is provided	12m in higher fire-risk area <sup>1,2</sup> 25m in normal fire-risk area 45m in a lower fire-risk area <sup>3</sup>

**Note 1:**

Where there are small higher-risk areas this travel distance should apply. Where the risk assessment indicates that the whole building is higher risk, seek advice from a competent person.

**Note 2:**

Some rooms are considered as places of special fire hazard, e.g. rooms used for highly flammable paint spraying. Shorter travel distances are generally required for these areas, e.g. 18m where there is more than one escape route, and 9m with a single escape route.

**Note 3:**

The travel distance for lower risk premises should only be applied in exceptional cases in the very lowest risk premises where densities are low, occupants are familiar with the premises, excellent visual awareness, and very limited combustibles.

The travel distances given in Table 2 are based on those recommended in Approved Document B of the Building Regulations<sup>24</sup> and are intended to complement the other fire safety recommendations in Approved Document B. Your current escape route travel distances may be different from these since they may be based on recommendations made in alternative guidance.

Where your route leads to more than one final exit, but only allows initial travel in a single direction (e.g. from a room or dead end, see Figures 27 and 28), then this initial travel distance should be limited to that for a 'single escape route' in Table 2. However, your total travel distance should not exceed that for 'more than one escape route'.

### Measuring travel distance

The figures that follow are schematic only and are intended to represent part of a larger building.

The route taken through a room or space will be determined by the layout of the contents, e.g. machinery, storage racking (Figure 23). It is good practice to ensure routes to the exits are kept as direct and short as possible. In a small room there may be only one exit but in a larger room or area there may be many exits.

In some cases, where the contents are moved around or the space is liable to frequent change, e.g. in a storage area or where racking is movable, you should ensure that the exits, or the routes to them, do not become blocked or the length of the route is not significantly extended.

Figure 23: Measuring travel distance

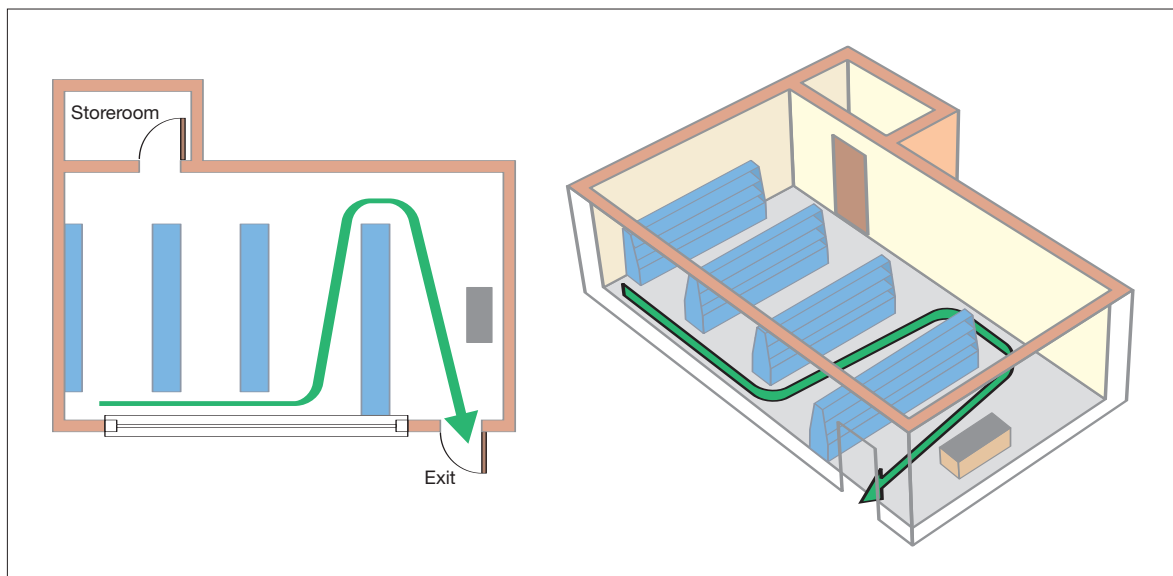

### Inner rooms

Where the only way out of a room is through another room (Figure 24), an unnoticed fire in the outer room could trap people in the inner room. This means of exit should be avoided where possible. If, however, this cannot be achieved then adequate warning of a fire should be provided by **any one** of the following means:

- a vision panel between the two rooms providing adequate vision to give an indication of the conditions in the outer room and the means of escape;
- a large enough gap between the dividing wall and the ceiling, e.g. 500mm, so that smoke will be seen;
- an automatic smoke detector in the outer room that will sound a warning in the inner room.

In addition, the following points should also be considered:

- restrict the number of people using an inner room to 60.
- access rooms should be under the control of the same person as the inner room.
- the travel distance from any point in the inner room to the exit from the access room should be restricted to escape in one direction only (see Table 2), unless there are alternative exits from the access room.
- no one should have to pass through more than one access room while making their escape.
- the outer room should not be an area of high fire risk.

Figure 24: Inner rooms

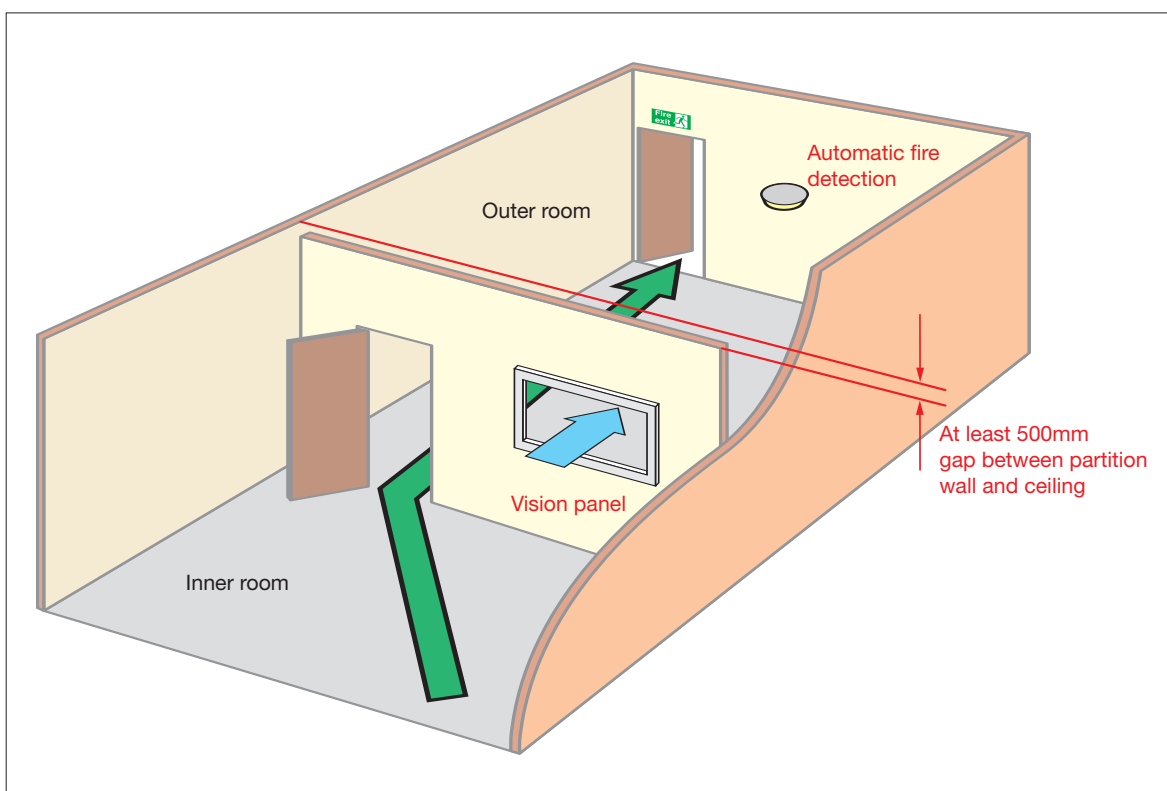

### Alternative exits

Where alternative exits from a space or room are necessary they should wherever possible be located at least 45° apart (see Figure 25) unless the routes to them are separated by fire-resisting construction (see Figure 26). If in doubt consult a competent person.

Figure 25: Alternative exits

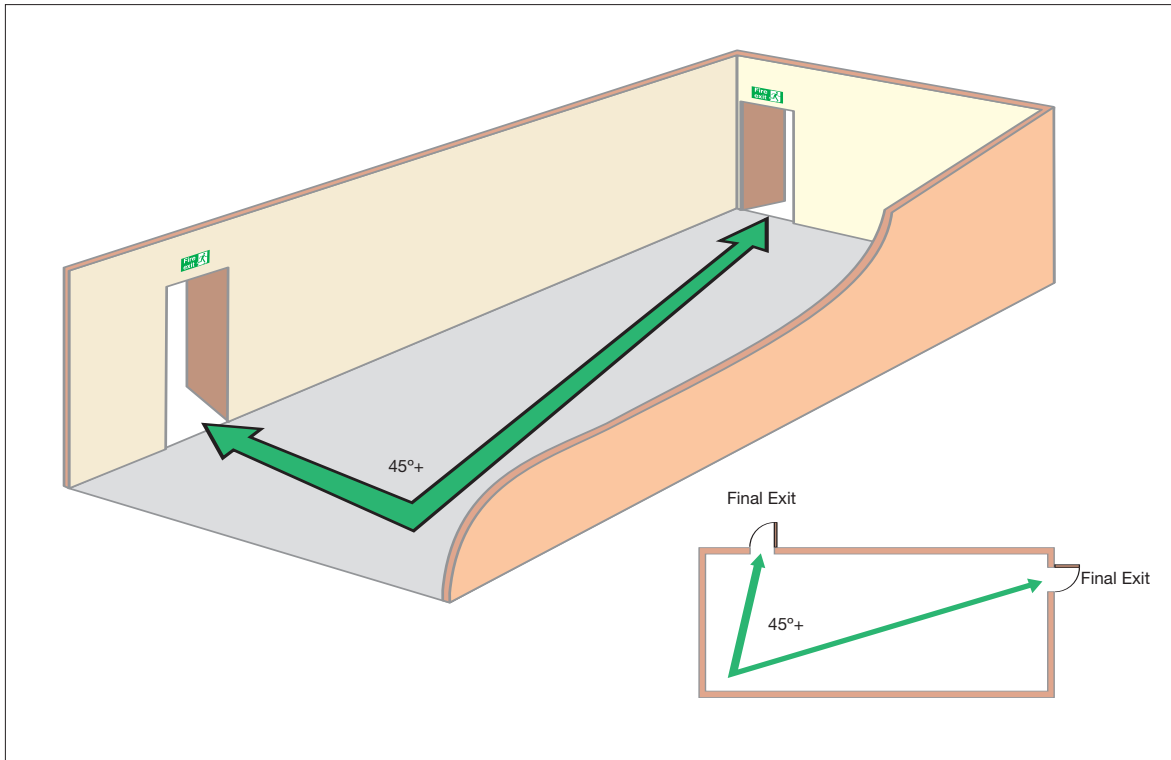
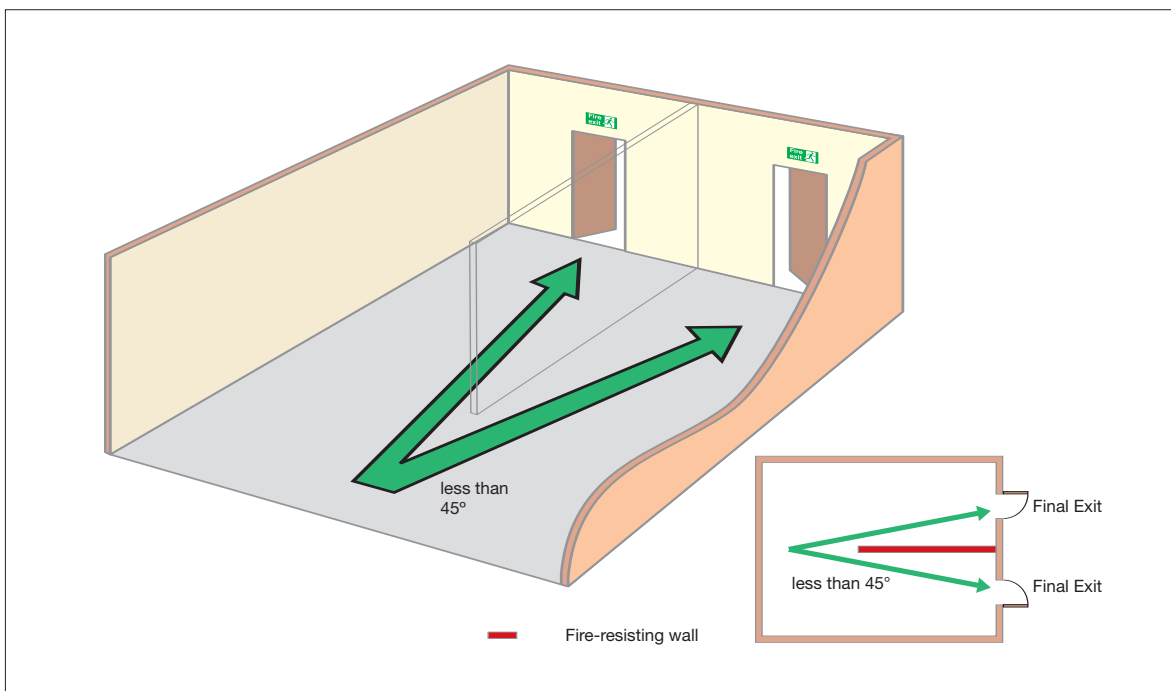

Figure 26: Alternative exits (separated by fire-resisting construction)



### Measuring travel distances for initial dead-end travel

Where the initial direction of travel in an open area (see Figure 27) is in one direction only or within an inner room (see Figure 28), the travel distance (A–B) should be limited to that for a ‘single escape route’ in Table 2.

Any alternative exits should be positioned to ensure that a fire will not compromise both exits. The maximum total travel distance recommended in Table 2 should apply to the nearest exit (Figure 27 and 28, distance A–C). However, since you have two exits, your total travel distance should not exceed that for ‘more than one escape route’ in Table 2.

Figure 27: Measuring travel distance from initial dead end (open plan)

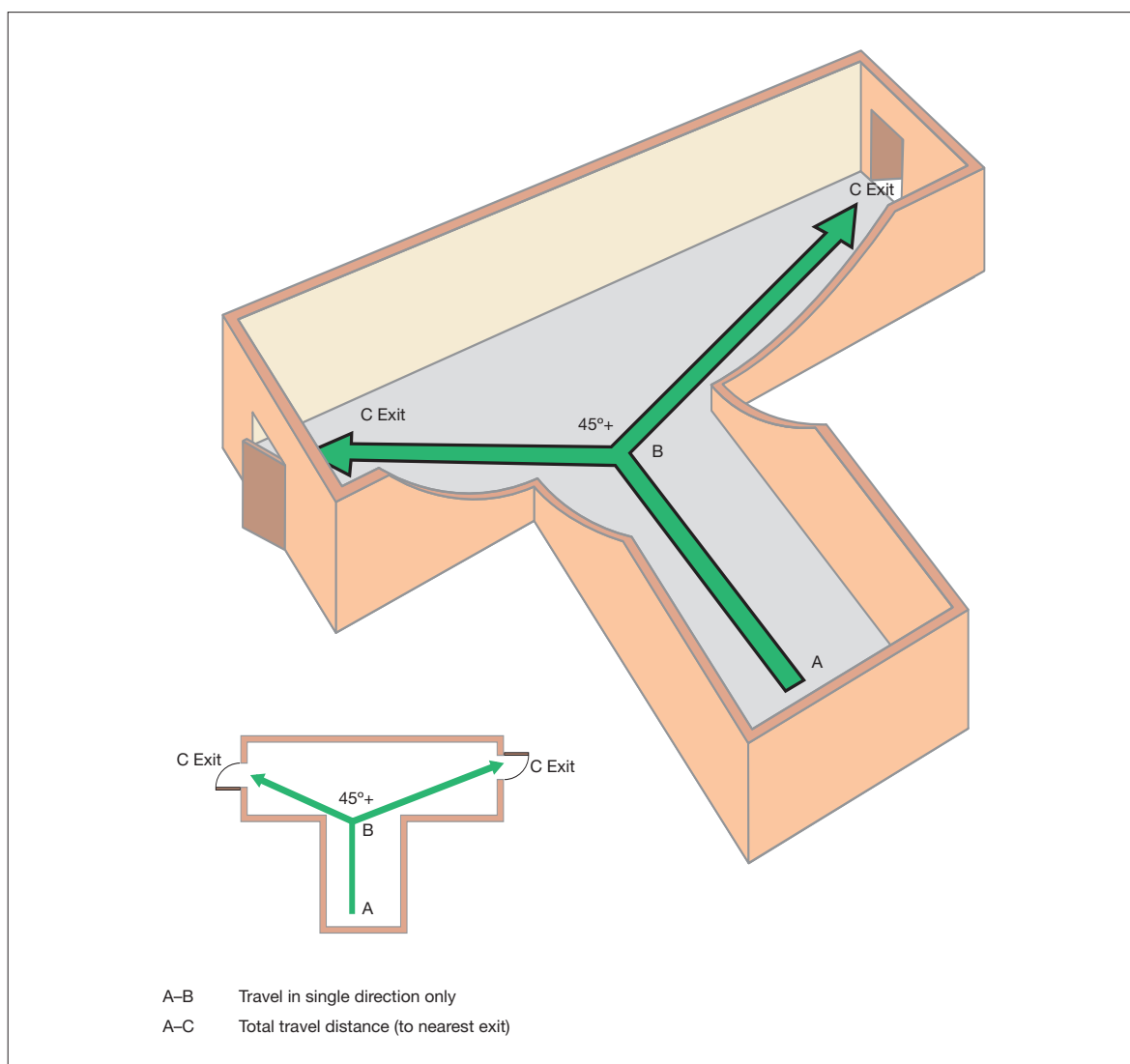
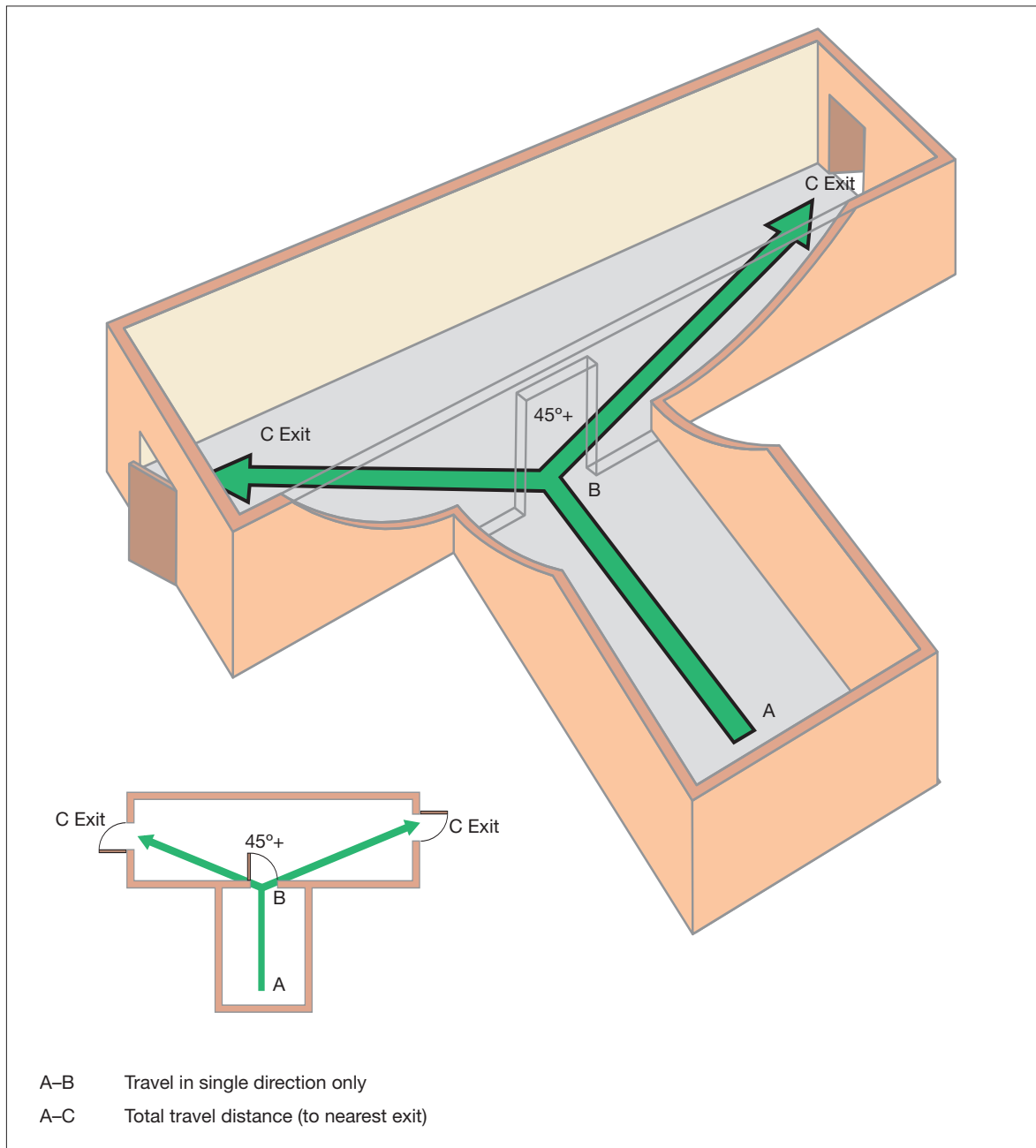

Figure 28: Measuring travel distance from initial dead end (inner room)



**Note:** Additional measures are necessary to give warning of fire for inner rooms (see Figure 24).

#### Escape routes with dead-end conditions

If your premises has escape routes from which escape can be made in one direction only (a dead end), then an undetected fire in that area could affect people trying to escape. To overcome this problem, limit the travel distance (see Table 2) and use one of the following solutions:

- Fit an automatic fire detection and warning system in those areas where a fire could present a risk to the escape route (see Figure 29).
- Protect the escape route with fire-resisting construction to allow people to escape safely past a room in which there is a fire (see Figure 30).
- Provide an alternative exit (see Figure 31).

Alternative approaches may be acceptable, although expert advice may be necessary.

Figure 29: Dead-end conditions with automatic fire detection

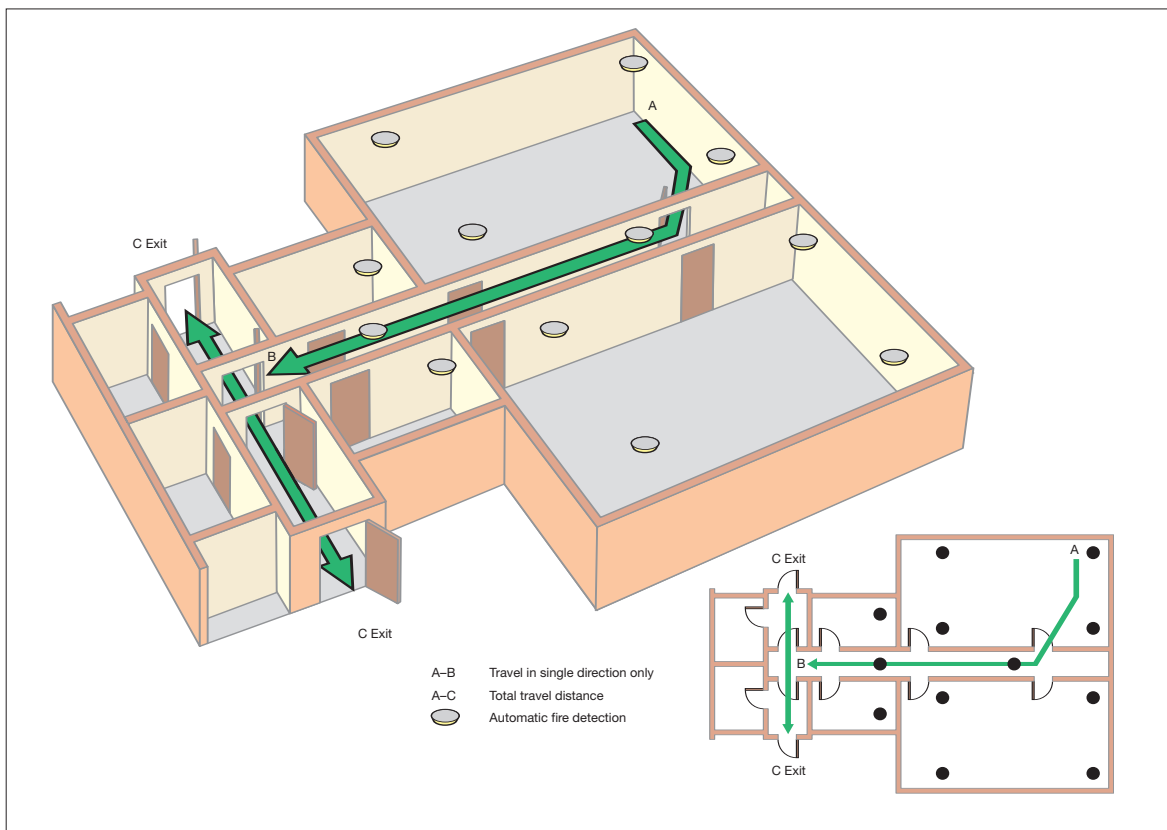

Figure 30: Dead-end conditions with fire-resisting construction

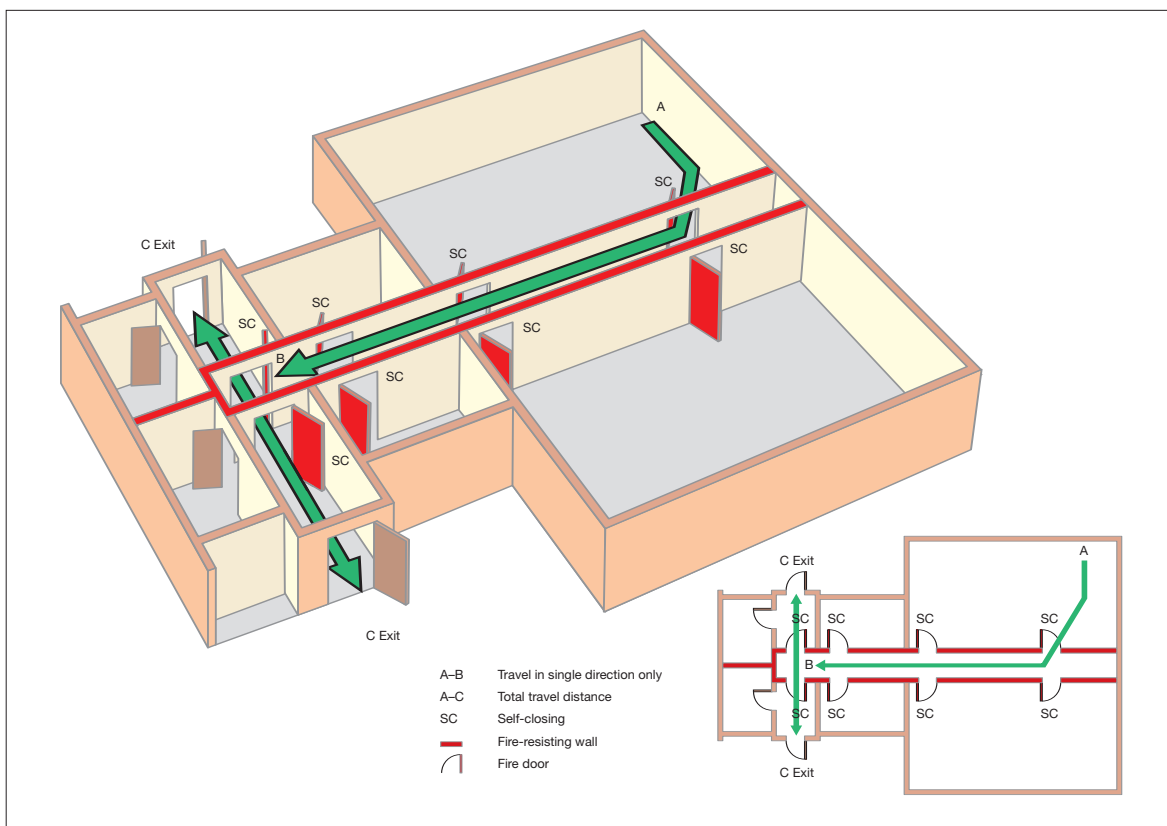
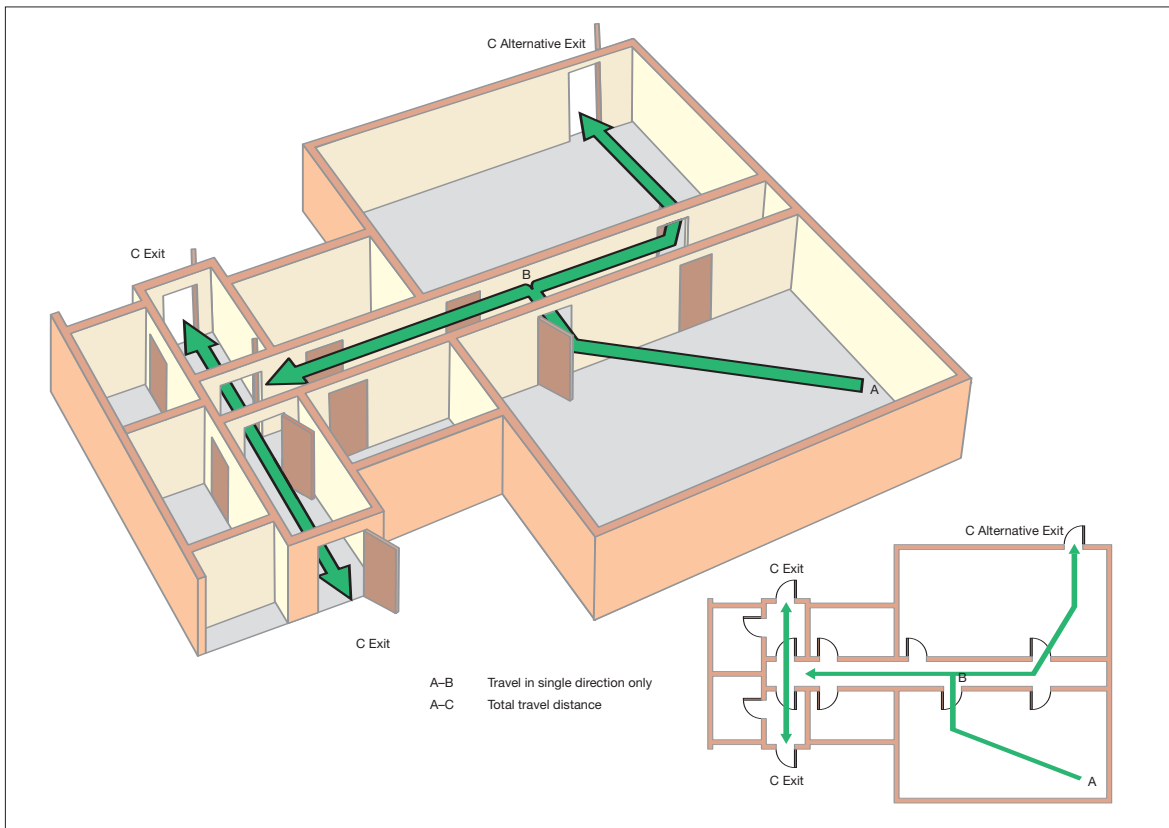

Figure 31: Dead-end conditions provided with an alternative exit



### Basements, escape and protection

In all buildings with basements (other than very small basements), stairways serving upper floors should preferably not extend to the basement and in any case should not do so where they are the only stairway serving the upper floors. Any stairway that extends from the basement to the upper floors should be separated at basement level by a fire-resisting lobby or corridor between the basement and the stairway. All basements used by more than 60 people, or where there are no exits directly to a place of total safety, should have at least two protected escape stairways.

In high risk premises there should be an alternative stairway from the basement to ground level, unless there is a suitable alternative route to the final exit.

Wherever possible all stairways to basements should be entered at ground level from the open air, and should be positioned so that smoke from any fire in the basement would not obstruct any exit serving the other floors of the building.

Where any stairway links a basement with the ground floor, the basement should be separated from the ground floor, preferably by two 30-minute fire doors, one at basement and one at ground floor level (see Figure 32). In a factory, the basement can be separated by one 60-minute fire door at basement level, or one 30-minute fire door where the basement is small and does not present a high fire risk.

Any floor over a basement should provide 60 minutes fire resistance. For smaller premises 30 minutes may be acceptable. Where this is impractical, and as long as no smoke can get through the floor, automatic smoke detection linked to a fire-alarm system which is audible throughout the premises could, as an alternative, be provided in the basement area. If in doubt, contact a competent person for more detailed advice.



Figure 32: Basement protection

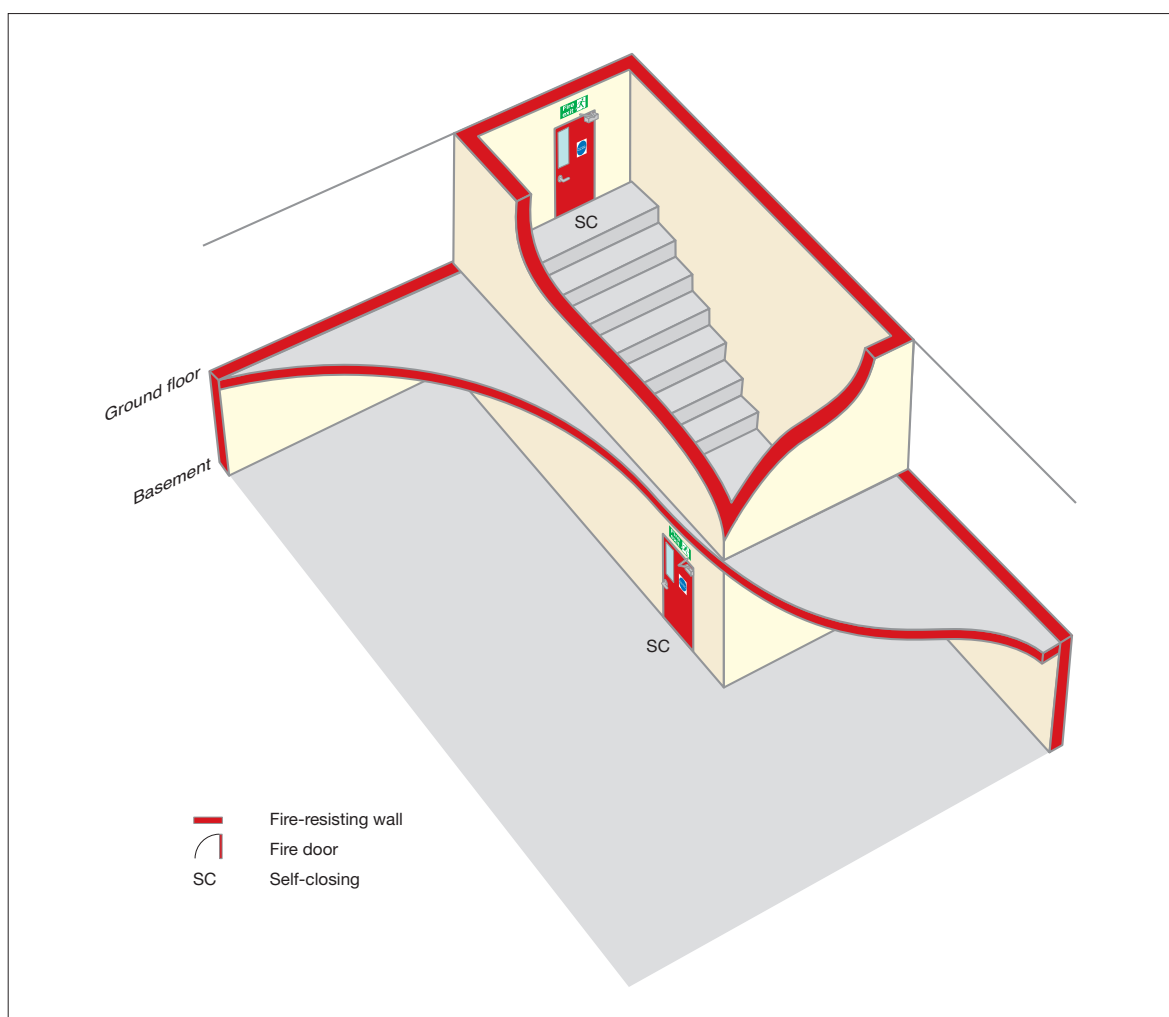

### Subdivision of corridors

If your premises has corridors more than 30m long, then generally these corridors should be subdivided near the centre of the corridor with fire doors and, where necessary, fire-resisting construction to limit the spread of fire and smoke and to protect escape routes if there is a fire.

Where a corridor serves two exits from a floor, generally these corridors should be subdivided with fire doors to separate the two exits (see Figure 33).

Doors that are provided solely for the purpose of restricting the travel of smoke need not be fire doors, but will be suitable as long as they are of substantial construction, are capable of resisting the passage of smoke, and are self-closing. Smoke should not be able to bypass these doors, e.g. above a false ceiling, or via alternative doors from a room, or adjoining rooms, opening on either side of the subdivision.

Generally, false ceilings should be provided with barriers or smoke stopping over any fire doors. Where the false ceiling forms part of the fire-resisting construction this may not be necessary.

If you have doubts about subdivision of corridors, ask advice from a competent person.

Figure 33: Subdivision of corridor between two stairways or exits

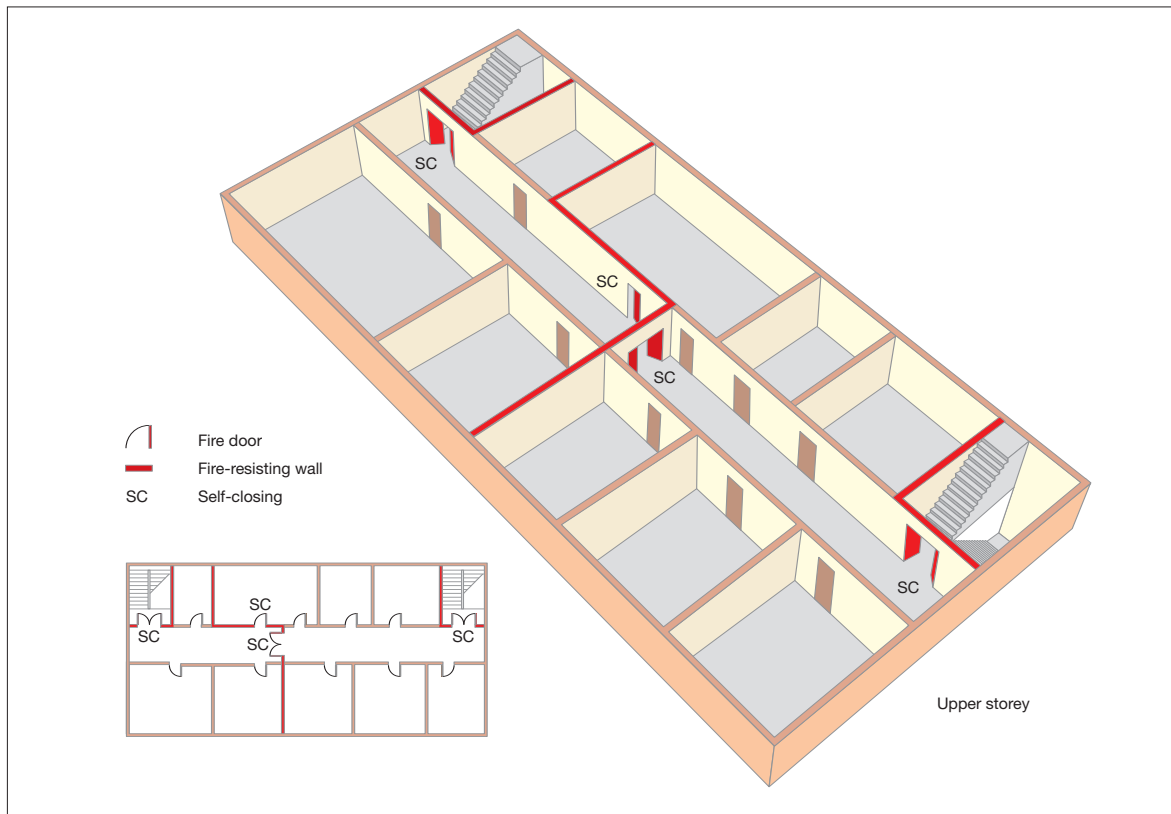

### Stairway enclosures

Stairways, if unprotected from fire, can rapidly become affected by heat and smoke, cutting off the escape route and allowing fire spread to other floors. However, if adequately protected, escape stairways can be regarded as places of reasonable safety to enable people to escape to a place of total safety.

In most premises designed and built to building regulations and served by more than one stairway, it is probable that these stairways will be protected by fire-resisting construction and will lead to a final exit. If any floor has an occupancy of over 60, each storey should have at least two exits, i.e. protected routes. The figure of 60 can be varied in proportion to the risk, lower risk slight increase, higher risk lower numbers of persons.

It is possible that you may have some stairways which have no fire protection to them. In this case they are not designed for escape and are normally known as accommodation stairways (see accommodation stairways on page 84).

If you have a protected stairway(s) then it is essential that you maintain that level of fire protection.

The benefit of protecting stairways from the effects of fire allows you to measure your travel distance from the farthest point on the relevant floor to the nearest storey exit rather than the final exit of the building.

If you do not have a protected stairway, depending on the outcome of your fire risk assessment, it may be that you can achieve an equivalent level of safety by other means. However, before doing so you should seek advice from a competent person.

If the building you occupy has floors which are occupied by organisations other than your own, you need to consider, as part of your fire risk assessment, the possibility that a fire may occur in another part of the building over which you may have no control and which may affect the protected stairway if allowed to develop unchecked. If your fire risk assessment shows that this may be the case and people using any floor would be unaware of a developing fire, then additional fire-protection measures may be required, e.g. an automatic fire-detection and warning system. If this is required you will need to consult and co-operate with other occupiers and building managers.

You may find that stairways in your building are provided with protected lobbies or corridors at each floor level, except the top floor (Figure 34). Although these are not generally necessary for means of escape in multi-stairway buildings

of less than 18m high, they may have been provided for other reasons (e.g. firefighting access). In all cases protected corridors, lobbies and stairways must be kept clear of combustibles and obstructions.

Figure 34: Examples of a stairway with protected lobby/corridor approach

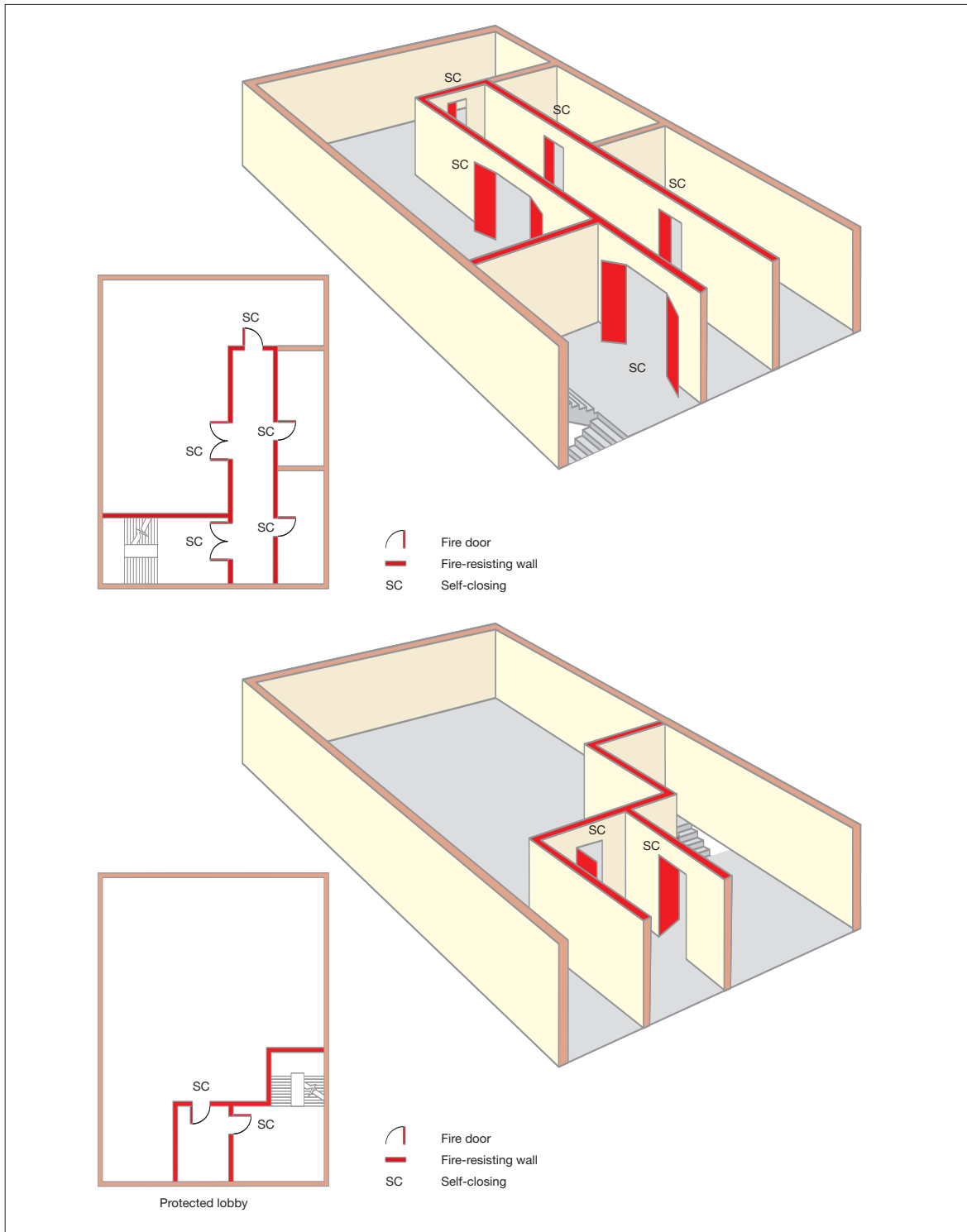

Ideally stairway enclosures should lead directly to a final exit. If your premises has only one stairway from the upper floor(s) which does not lead directly to a final exit, adopt one of the following arrangements:

- provide a protected route from the foot of the stairway enclosure leading to a final exit (see Figure 35); or
- provide two exits from the stairway, each giving access to a final exit via routes which are separated from each other by fire-resisting construction (see Figure 36).

Figure 35: Examples of a protected route from a stairway to a final exit

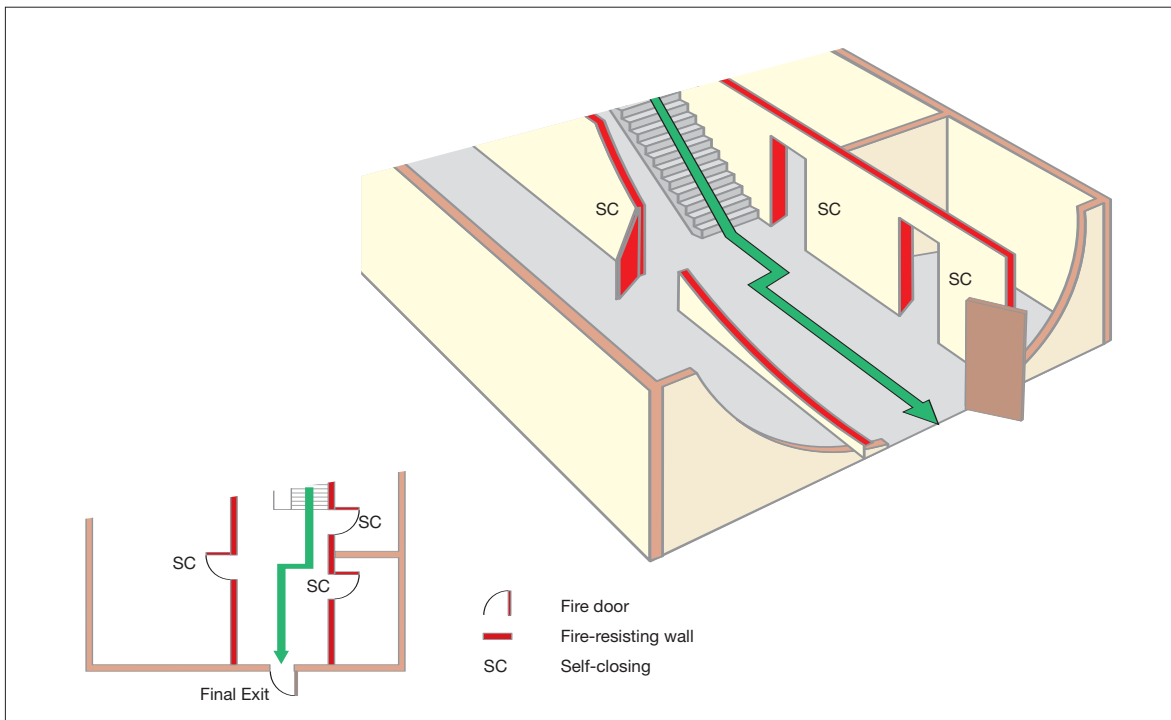
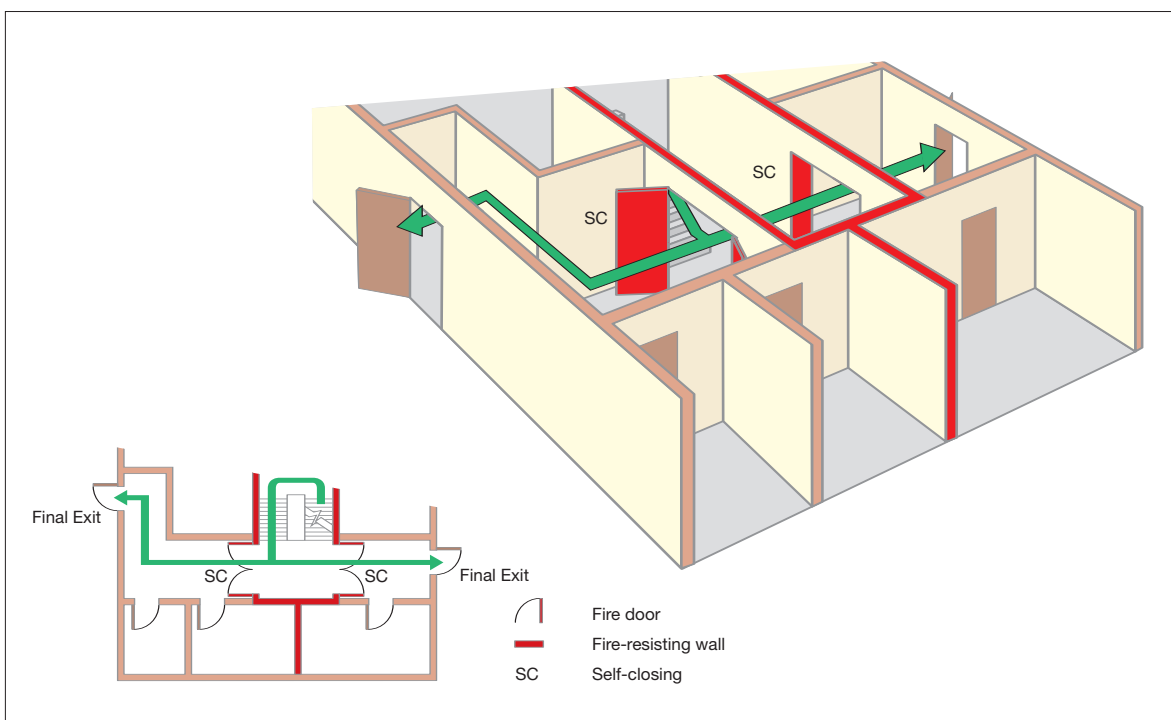

Figure 36: Examples of two escape routes from a stairway to final exits



### Separation of protected stairways

Where there are two or more protected stairways, the routes to final exits should be separated by fire-resisting construction so that fire cannot affect more than one escape route at the same time (see Figure 37).

Figure 37: Separation of protected stairways

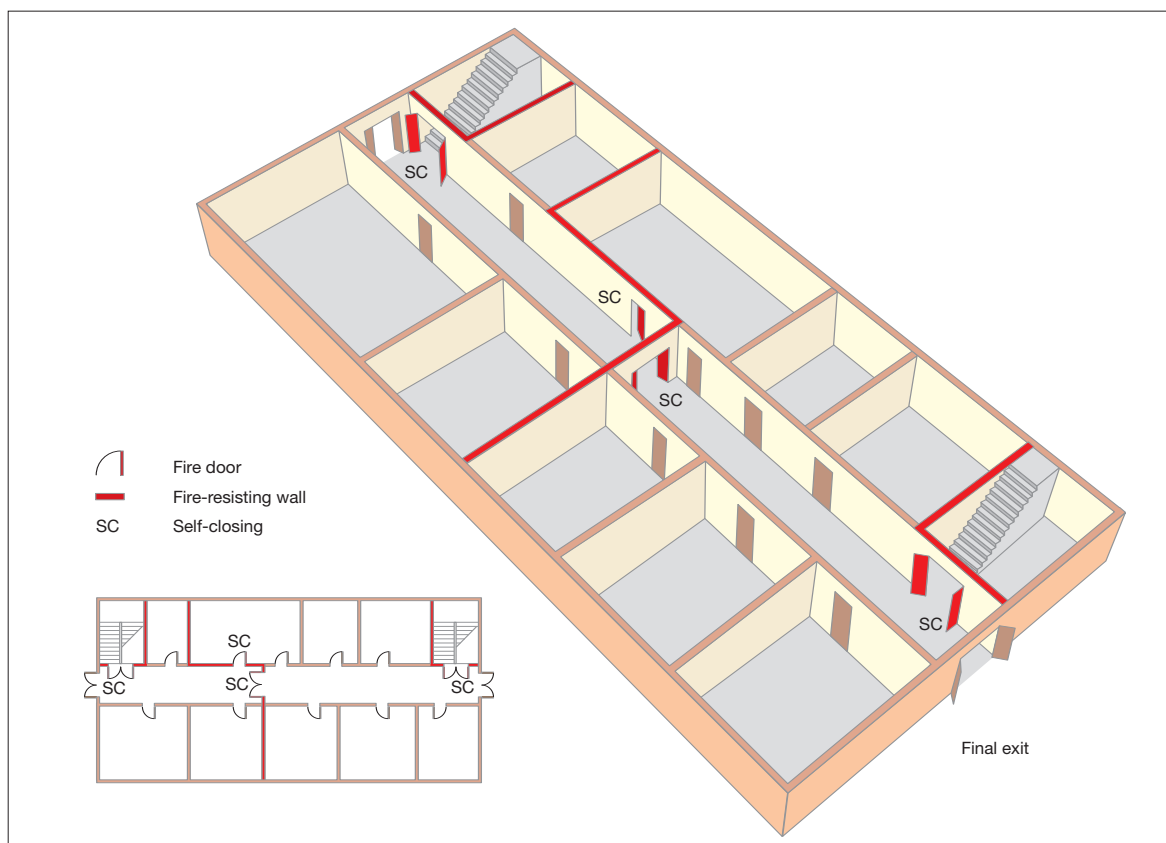

### Creating a stairway bypass route

No one should have to pass through a protected stairway to reach another stairway. Options to avoid this include:

- using intercommunicating doors between rooms adjacent to the stairway; such doors must be available at all times when the building is occupied (see Figure 38);
- using balconies and other features to bypass the stairway; or
- as long as there is enough space, create a bypass corridor around the stairway enclosure.

Figure 38: A stairway bypass route

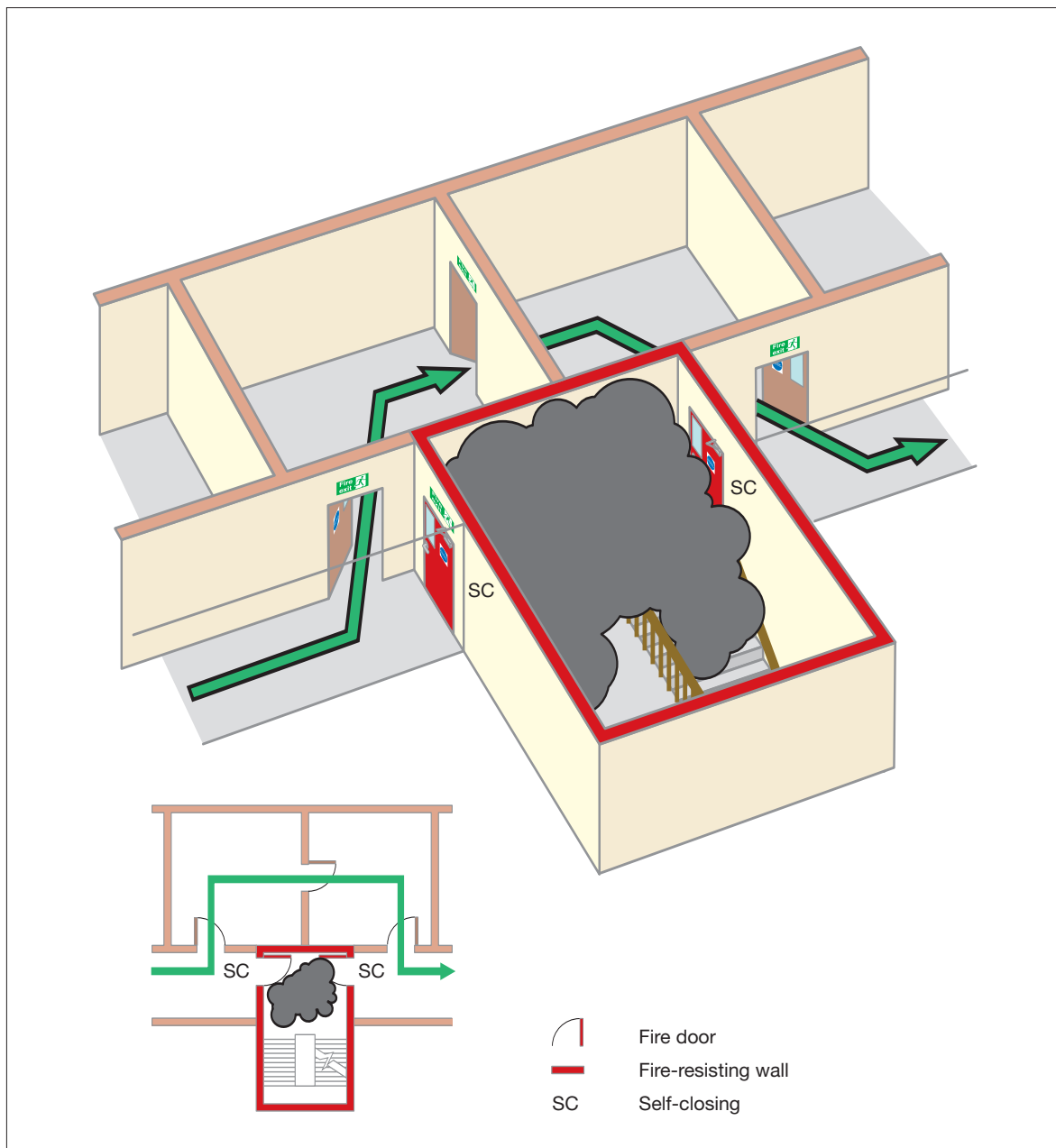

### Reception areas

Reception or enquiry areas should only be located in protected stairways where the stairway is not the only one serving the upper floors, the reception area is small (less than 10m<sup>2</sup>) and is of low fire risk.

### Accommodation stairways

If you have stairways that are used for general communication and movement of people in the premises, and they are not designated as fire escape stairs then these are called 'accommodation stairways'. They may not require fire separation from the remainder of

the floor as long as they do not pass through a compartment floor, or people do not have to pass the head of such a stairway in order to access a means of escape stairway. However, experience shows that many people will continue to use these as an escape route.

Accommodation stairways should not normally form an integral part of the calculated escape route; however, where your fire risk assessment indicates that it is safe to do so, then you may consider them for that purpose. In these circumstances it may be necessary to seek advice from a competent person to verify this.

### External stairways

To be considered a viable escape route, an external stairway should normally be protected from the effects of a fire along its full length. This means that any door, window (other than toilet windows) and walls within 1.8m horizontally and 9m vertically below any part of the stairway should be fire-resisting. Windows should be fixed shut and doors self-closing (see Figure 39).

Consider protecting the external stairway from the weather as the treads may become slippery, e.g. due to algae, moss or ice. If this is not possible, you must ensure that the stairway is regularly maintained. Consider fixing non-slip material to the treads.

Figure 39: Protection to an external stairway

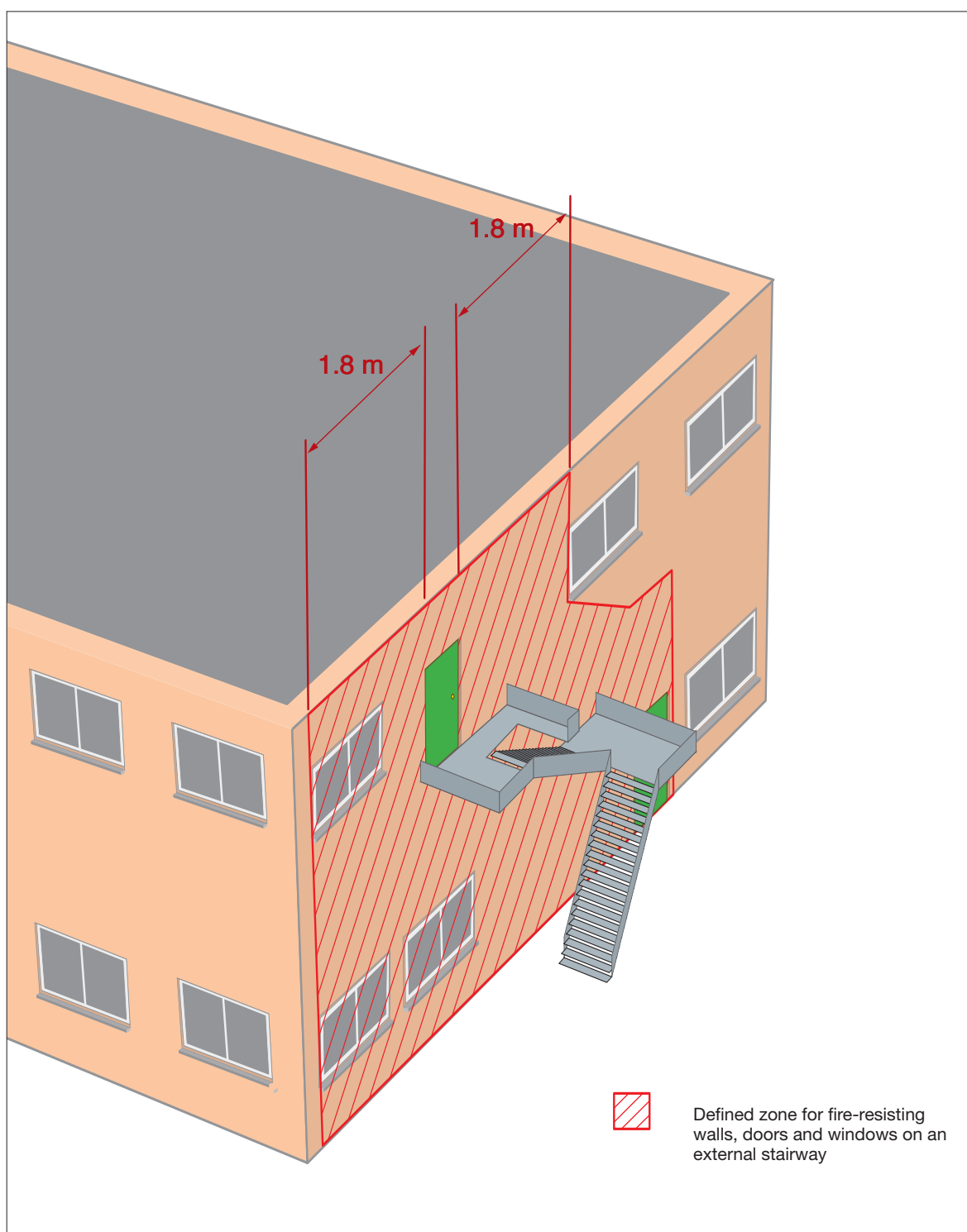

### **Spiral and helical stairways**

Spiral and helical stairways are usually acceptable only in exceptional situations, e.g. for a maximum of 50 people who are not members of the public. The stairway should not be more than 9m in total height and not less than 1.5m in diameter with adequate headroom. A handrail should be continuous throughout the full length of the stairway.

However spiral and helical stairways may be used as means of escape for more than 50 staff and may be used by the public if the stairways have been designed for the purpose. Further guidance is given in BS 5395-2,<sup>26</sup> including about type E (public) stairs under that standard.

### **Lifts**

Due to the danger of the power supplies to a lift being affected by a fire, lifts not specifically designed as 'firefighting' or 'evacuation' lifts are not normally considered acceptable as a means of escape. However, where a lift and stairway for a means of escape are incorporated in a fire-resisting shaft which has a final exit from it at the access level, and the lift has separate electrical supply to that of the remainder of the building, then that lift, subject to an agreed fire risk assessment, may be acceptable as a means of escape in case of fire.

Lifts are housed in vertical shafts that interconnect floors and compartments, therefore precautions have to be taken to protect people from the risk of fire and smoke spreading from floor to floor via the lift shaft. Such precautions may include:

- separating the lift from the remainder of the storey using fire-resisting construction and access via a fire door;
- ensuring the lift shaft is situated in a protected enclosure which may also be a stairway enclosure; and
- providing ventilation of at least 0.1m<sup>2</sup> at the top of each lift-well to exhaust any smoke.

### **Roof exits**

It may be reasonable for an escape route to cross a roof. Where this is the case, additional precautions will normally be necessary:

- The roof should be flat and the route across it should be adequately defined and well-illuminated where necessary, with normal electric and emergency escape lighting. The route should be non-slip and guarded with a protective barrier.
- The escape route across the roof and its supporting structure should be constructed as a fire-resisting floor.
- Where there are no alternatives other than to use a roof exit, any doors, windows, roof lights and ducting within 3m of the escape route should be fire-resisting.
- The exit from the roof should be in, or lead to, a place of reasonable safety where people can quickly move to a place of total safety.
- Where an escape route passes through or across another person's property, you will need to have a robust legal agreement in place to allow its use at all times when people are on your premises.
- These should not normally be used by members of the public.

A typical escape route across a roof is illustrated in Figure 40.

External escape routes should receive routine inspection and maintenance to ensure they remain fit for use. You will need to ensure that any legal agreements in place cover access for maintenance of the escape route.



Figure 40: An escape route across a roof

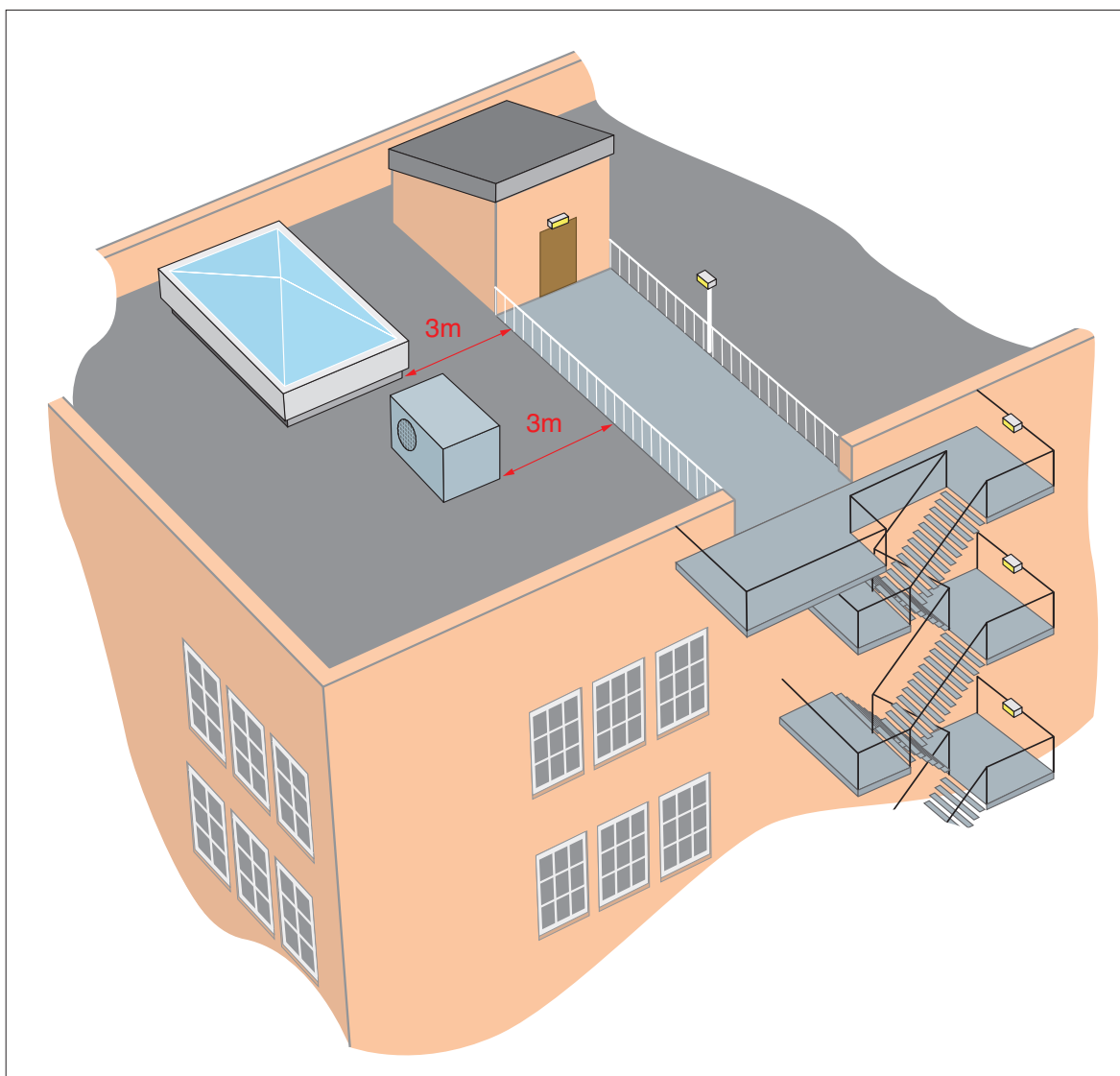

### Revolving doors, wicket doors, sliding doors and roller shutters

Revolving doors should not normally be considered as escape doors unless the leaves fold outward to form a clear opening upon pressure from within, or standard doors of the required exit width are provided next to the revolving door.

Ideally wicket doors or gates should have a minimum opening height of 1.5m. The bottom of the door should not be more than 250mm above the floor and the width should be preferably more than 500mm but not less than 450mm. Normally wicket doors will only be suitable for up to 15 members of staff; however, in areas of a higher fire risk, this should be reduced to a maximum of three.

Loading and goods delivery doors, shutters (roller, folding or sliding), up-and-over doors and similar openings are not normally suitable for use as a final exit. However, they may be suitable for escape from areas of normal risk by small numbers of staff as long as they are not likely to be obstructed and can be easily and immediately opened manually, even if normally power-operated, and the staff are familiar with the escape routes.

Sliding doors are not normally suitable on escape routes unless they are for the sole use of members of staff. Where provided, a notice with the words 'slide to open', with an arrow pointing in the direction of opening, should be permanently displayed at about eye level on the face of the doors.

### Final exit doors and escape away from the premises

Good escape routes to a final exit will be of little benefit if the occupants are not able to get out of the building and quickly disperse from the area to a place of total safety. It is also important to consider where people will go once they have evacuated from the premises.

The matters that you should consider include the following:

- Final exit doors should be quickly and easily openable without a key or code in the event of a fire. Where possible, there should be only one fastening. See Appendix B3 for more information on security fastenings.
- Final exit doors should not lead people into an enclosed area from which there is no further escape.
- Where a final exit discharges into an enclosed area, further access to a place of total safety should be available by means of further doors or gates that can be easily opened in a manner similar to the final exit.

## 4.2 Escape route layout

The examples listed in Table 3 show typical escape route solutions for a range of common building layouts. In each case the solution is for a normal risk building unless otherwise illustrated.

These are not intended to be prescriptive or exhaustive, but merely to help you understand how the principles of means of escape may be applied in practice.

They are illustrative of the key features of escape route layouts and not intended to be real building layouts or to scale.

**You do not need to read all of this section, you only need to consider those figures and the accompanying text which most closely resemble your premises. If your premises do not resemble these then you should seek advice from a competent person. These examples are intended to represent your existing layout; they are not to be used as design guidance.**

In all of these examples the following basic principles apply:

- The farthest point on any floor to the final exit or storey exit to a protected stairway is within the overall suggested travel distance (see Table 2).
- The route to and the area near the exit is kept clear of combustibles and obstructions.
- The fire-resisting stairway is kept clear of combustibles and obstructions.
- The escape route leads to a final exit.
- Where the stairway is not a protected stairway, the final exit is visible and accessible from the discharge point of the stairway at ground floor level.
- High-risk rooms do not generally open directly into a protected stairway.
- If your fire risk assessment shows that people using any floor would be unaware of a fire you may require additional fire-protection measures, e.g. an automatic fire-detection and warning system.
- There should be more than one escape route from all parts of the premises (rooms or storeys) except for areas or storeys with an occupancy of less than 60. The figure of 60 can be varied in proportion to the risk, for a lower risk there can be a slight increase, for a higher risk, lower numbers of persons should be allowed.

Table 3: Typical examples of escape route layouts

Single storey buildings (or the ground floor of a larger building)	
Ground floor (smaller) with more than one exit	See Figure 41
Ground floor (larger) with more than one exit	See Figure 42
Ground floor with a single exit (including a mezzanine)	See Figure 43
Multi-storey buildings with more than one stairway	
Two-storey, ground and one upper floor: lower risk premises (e.g. a warehouse storing sand, gravel and cement)	See Figure 44
Two-storey, ground and one upper floor: higher risk premises (e.g. a factory with paint spraying activities)	See Figure 45
Three-storey, basement, ground and one upper floor	See Figure 46
Four-storey, ground and up to three upper floors	See Figure 47
Tall building with a firefighting shaft	See Figure 48
Multi-storey buildings (or parts of buildings) with a single stairway	
Two-storey, ground and one upper floor	See Figure 49
Two-storey, basement and ground floor	See Figure 50
Three-storey, small basement, ground and one upper floor, with a separate single stairway to each	See Figure 51
Three-storey, basement, ground and one upper floor	See Figure 52
Four storey, ground and up to three upper floors	See Figure 53
Four storey, ground and up to three upper floors: higher risk premises (e.g. a factory with paint spraying activities) – protected lobbies/corridors	See Figure 54
Four storey, ground and up to three upper floors: higher risk premises (e.g. a factory with paint spraying activities) – protected with automatic fire detection	See Figure 55

If you do not have any of the stairway configurations given, and depending on the outcome of your fire risk assessment, it may be that you can achieve an equivalent level of safety by other means.

**The green arrows on the Figures 41–55 represent the travel distances given in Table 2 (page 71) which should be applied.**

If your building has more than a ground floor and three upper storeys, ask advice from a competent person.

**Single-storey buildings (or the ground floor of a larger building)**

**Ground floor with more than one exit**

Figures 41 and 42 show acceptable examples of smaller and larger premises respectively, with more than one exit.

*Figure 41: Ground floor (smaller) with more than one exit*

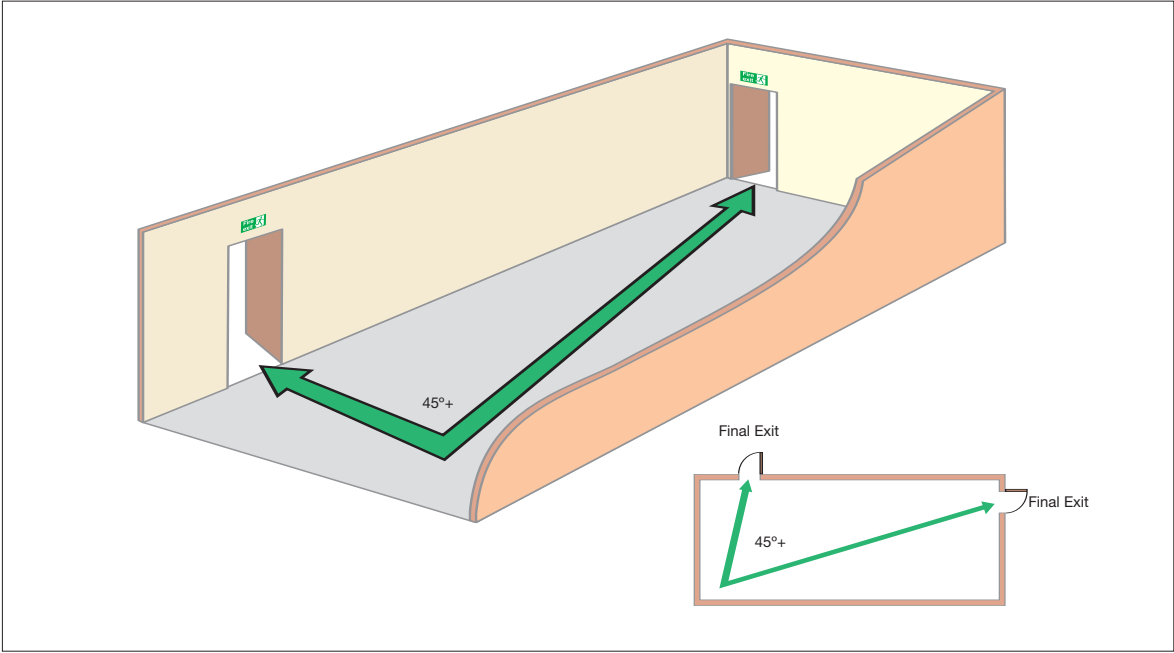

*Figure 42: Ground floor (larger) with more than one exit*

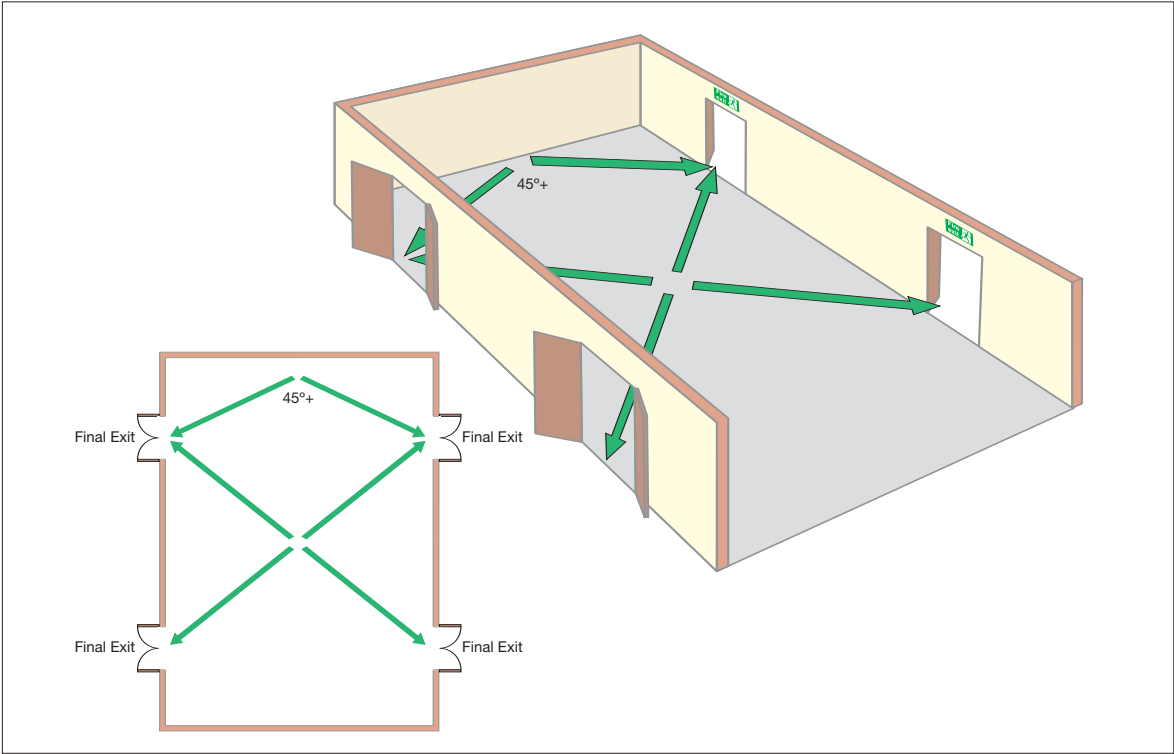

### Ground floor with a single exit (including a mezzanine)

Part of your premises may have only a single exit. The example shown in Figure 43 will be generally acceptable provided that part of the premises served only by a single exit (i.e. ground floor and mezzanine) accommodates no more than 60 people in total.

If your fire risk assessment shows that people using the mezzanine would be unaware of a fire, it may require additional fire-protection measures, e.g. an automatic fire-detection and warning system.

**Note:** A mezzanine covering more than half of the floor area may need to be treated as a separate floor (see two-storey buildings).

Figure 43: Ground floor with a single exit  
(including a mezzanine)

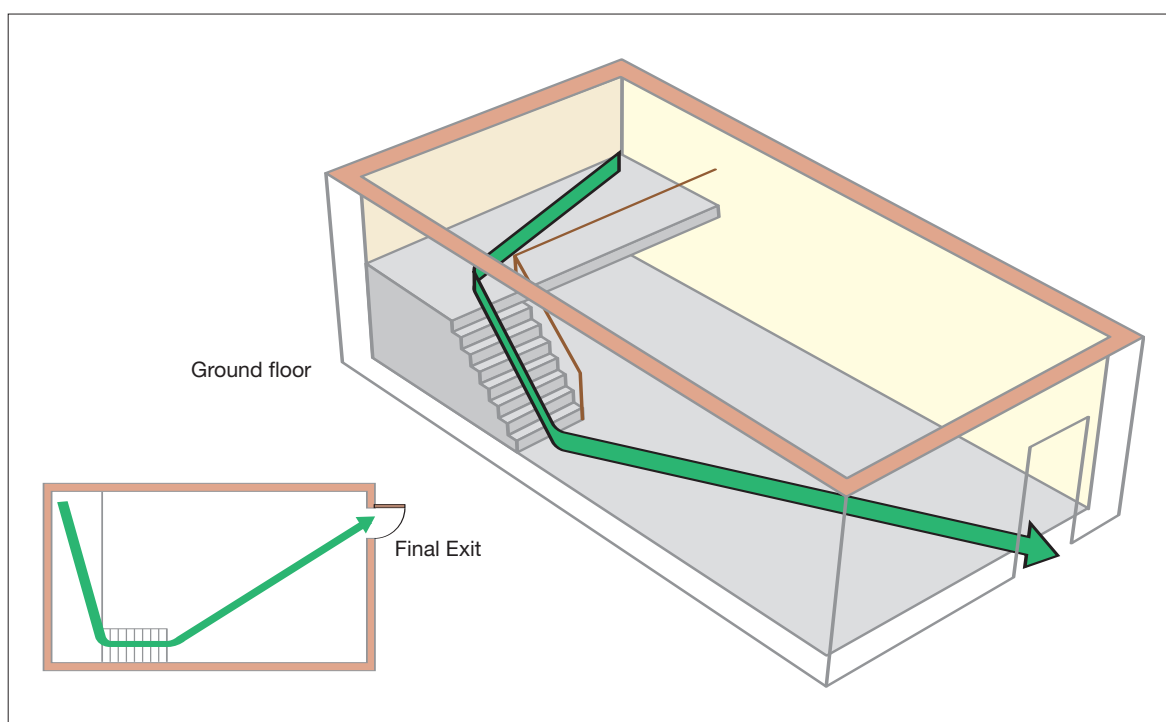

**Multi-storey buildings with more than one stairway**

**Two-storey, ground and one upper floor**

If your premises has a ground floor and one upper floor and these are served by more than one stairway, it is important to understand that you may not be able to meet the suggested travel distance to a final exit (see Table 2 on page 71). In this case, stairways may therefore need to be protected by a fire-resisting enclosure as shown.

The layout shown in Figures 44 and 45 will be generally acceptable as long as the farthest point on each of your floors to the storey exit (or to a final exit using an unprotected stair) is within the overall suggested travel distance (see Table 2 on page 71).

*Figure 44: Two-storey, ground and one upper floor: lower risk premises (e.g. a warehouse storing sand, gravel and cement)*

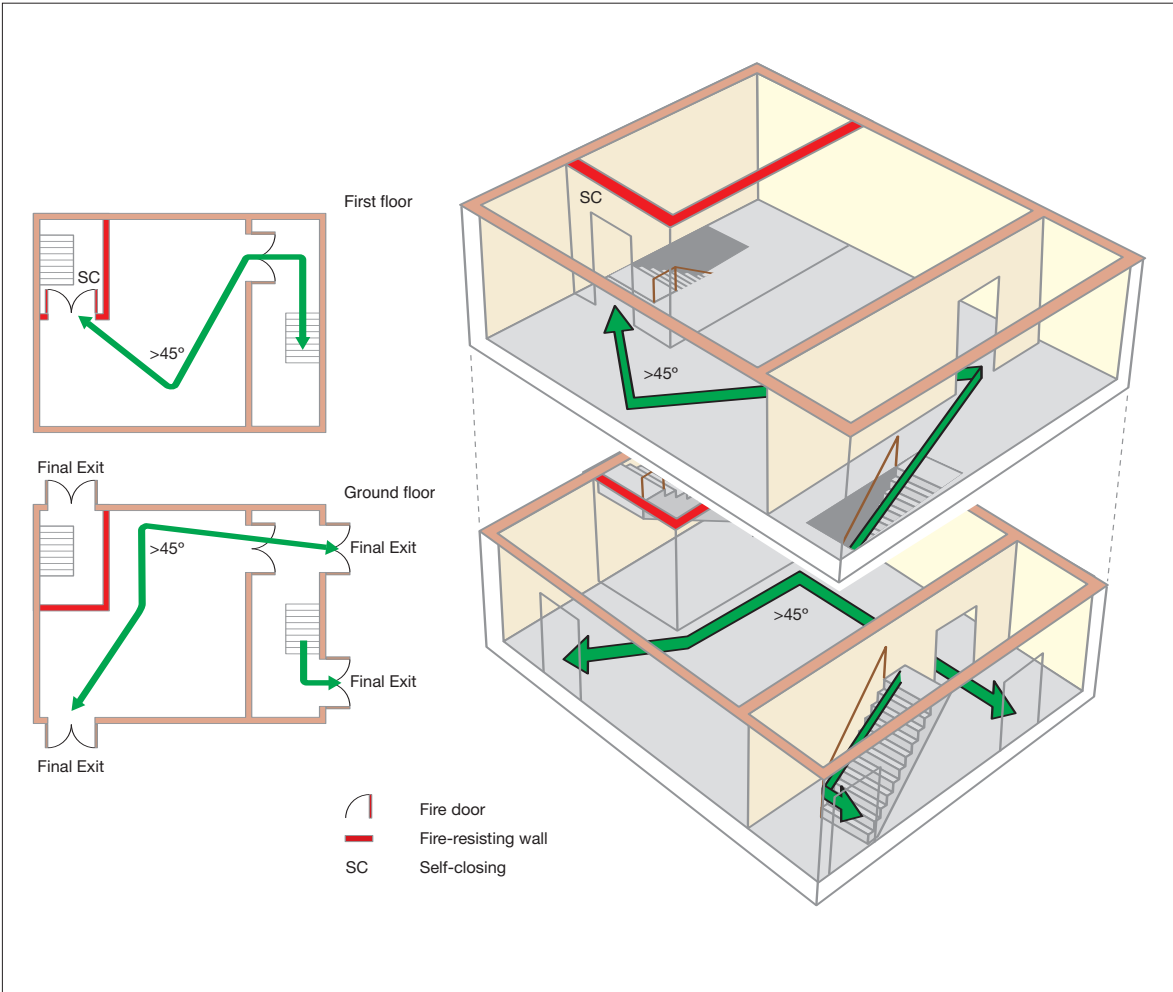
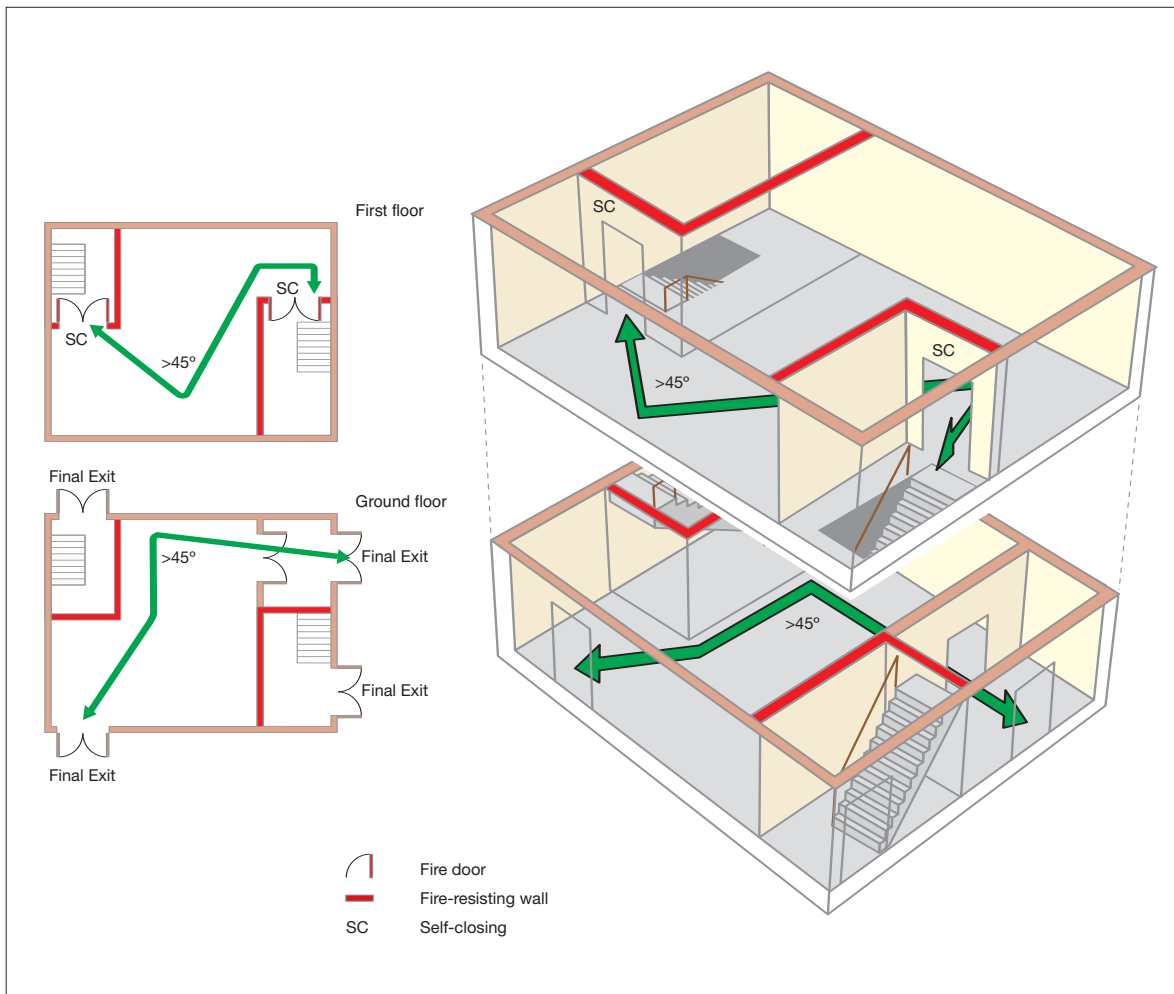

Figure 45: Two-storey, ground and one upper floor: higher risk premises (e.g. a factory with paint spraying activities)



### Three-storey, basement, ground and one upper floor

In premises with a basement, ground and first floor, served by more than one stairway, the layout shown in Figure 46 will be generally acceptable as long as the following apply:

- To overcome the restriction of travel distance the stairway has been completely enclosed in 30-minute fire-resisting construction and all doors onto the stairway are self-closing fire doors.
- The farthest point on all of the floors to the nearest storey exit is within the overall suggested travel distance (see Table 2 on page 71).

- Where the building incorporates a basement, any stairway from the basement that extends to the upper floors should be separated by a fire-resisting lobby or corridor between the basement and the protected stairway.
- If the basement is served only by a single stairway then it should accommodate no more than 60 people.

This principle applies to taller buildings (up to 18m). However, where your building has more than three upper storeys ask advice from a competent person.

Figure 46: Three-storey, basement, ground and one upper floor

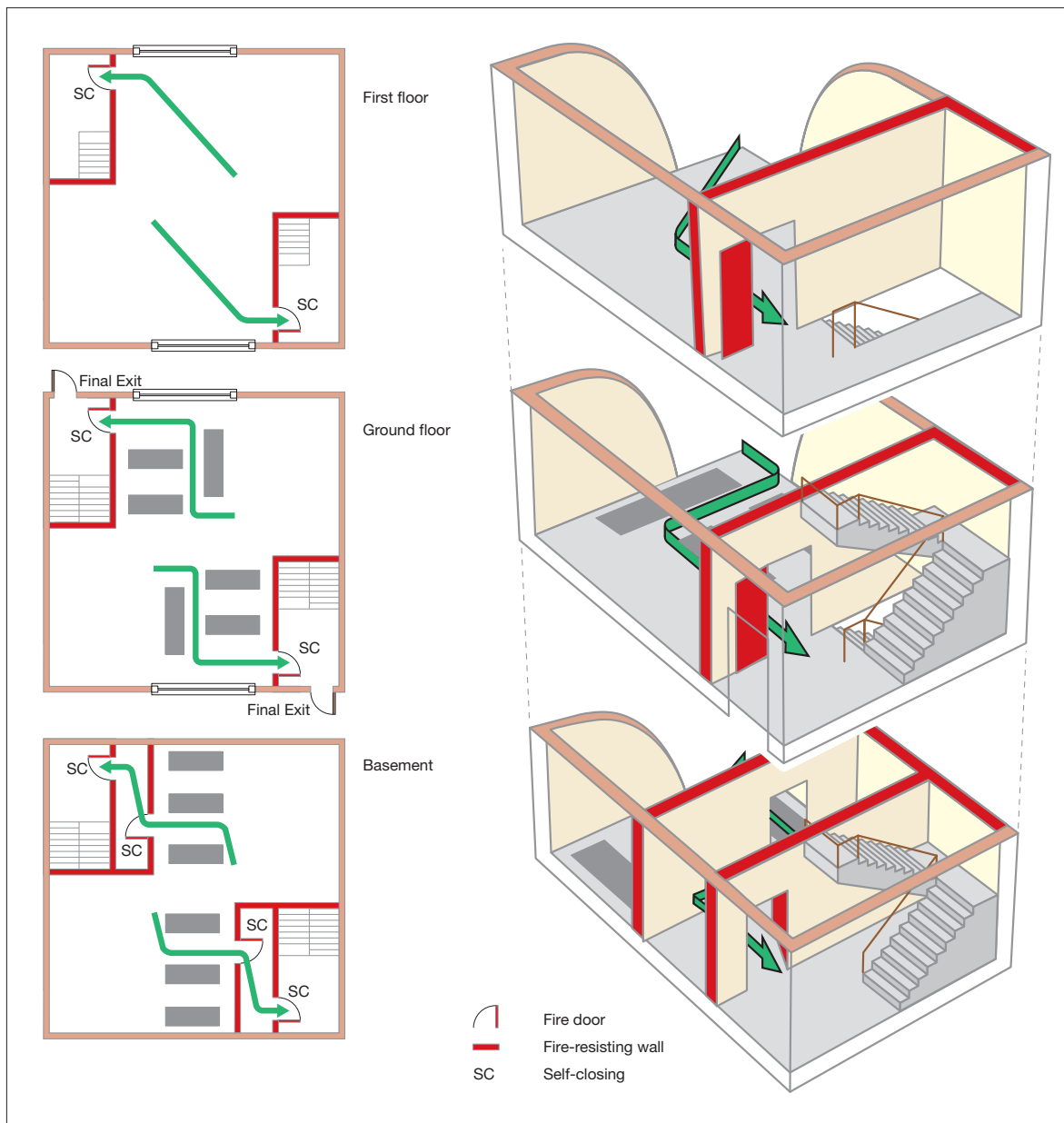



**Four-storey, ground and up to three upper floors**

In some premises, with a ground floor and up to three upper floors served by more than one stairway, it is important to understand that you are unlikely to be able to meet the suggested travel distance to a final exit (see Table 2 on page 71). In these circumstances it is necessary to protect the stairway by a fire-resisting enclosure as shown.

The layout shown in Figure 47 will be generally acceptable as long as the farthest point on all of the floors to the storey exit is within the overall suggested travel distance (see Table 2 on page 71).

This principle applies to taller buildings (up to 18m). However, where your building has more than three upper storeys ask advice from a competent person.

Figure 47: Four-storey, ground and up to three upper floors

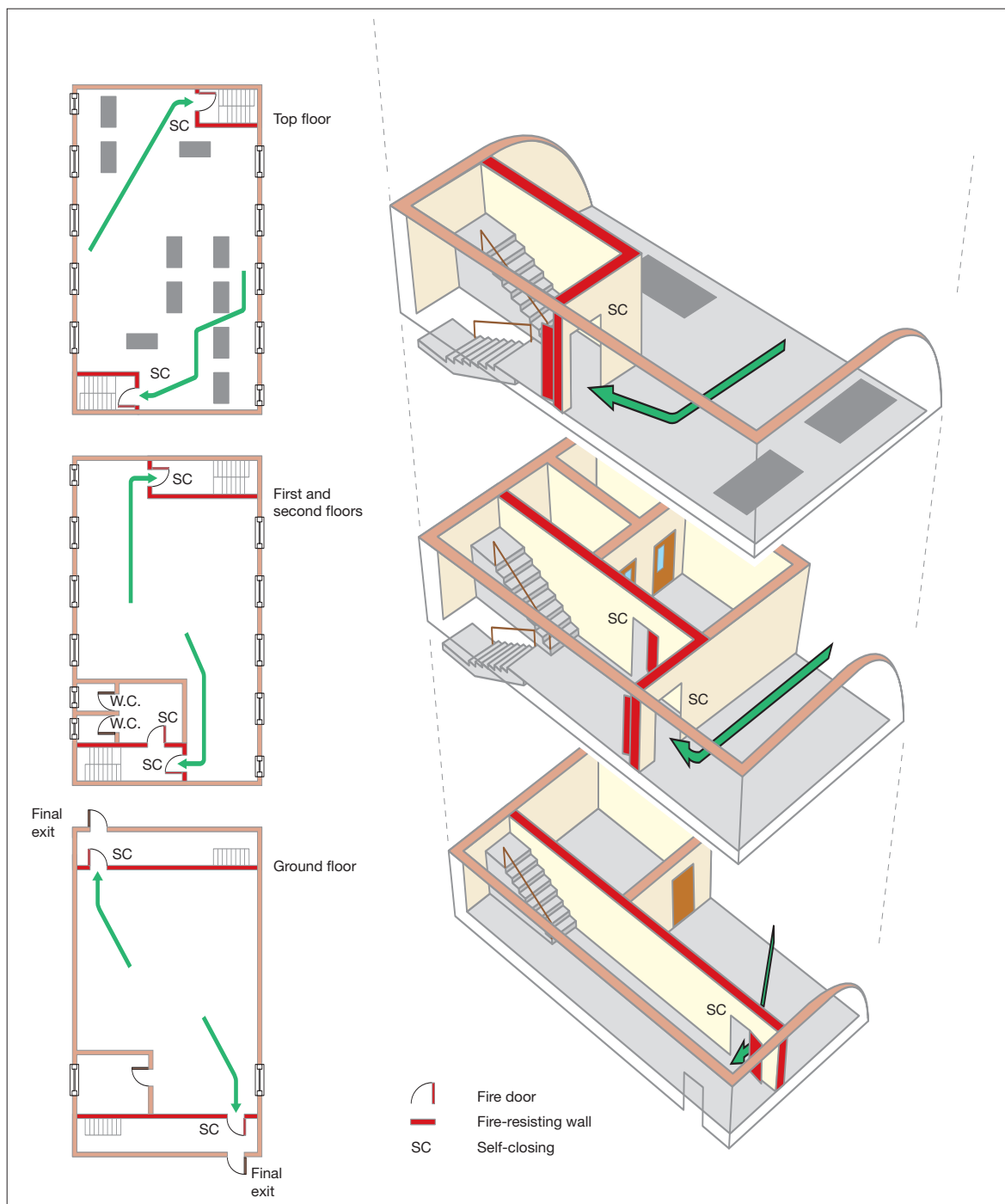

### Tall building with a firefighting shaft

Figure 48 shows a multi-storey building more than 18m high fitted with a firefighting shaft which is required for specific types of buildings. If the premises you occupy are situated in a building like this, you should ask the advice of a competent person. Further information may be found in BS 5588-5<sup>61</sup> and Approved Document B.<sup>24</sup>

Figure 48: Tall building with a firefighting shaft

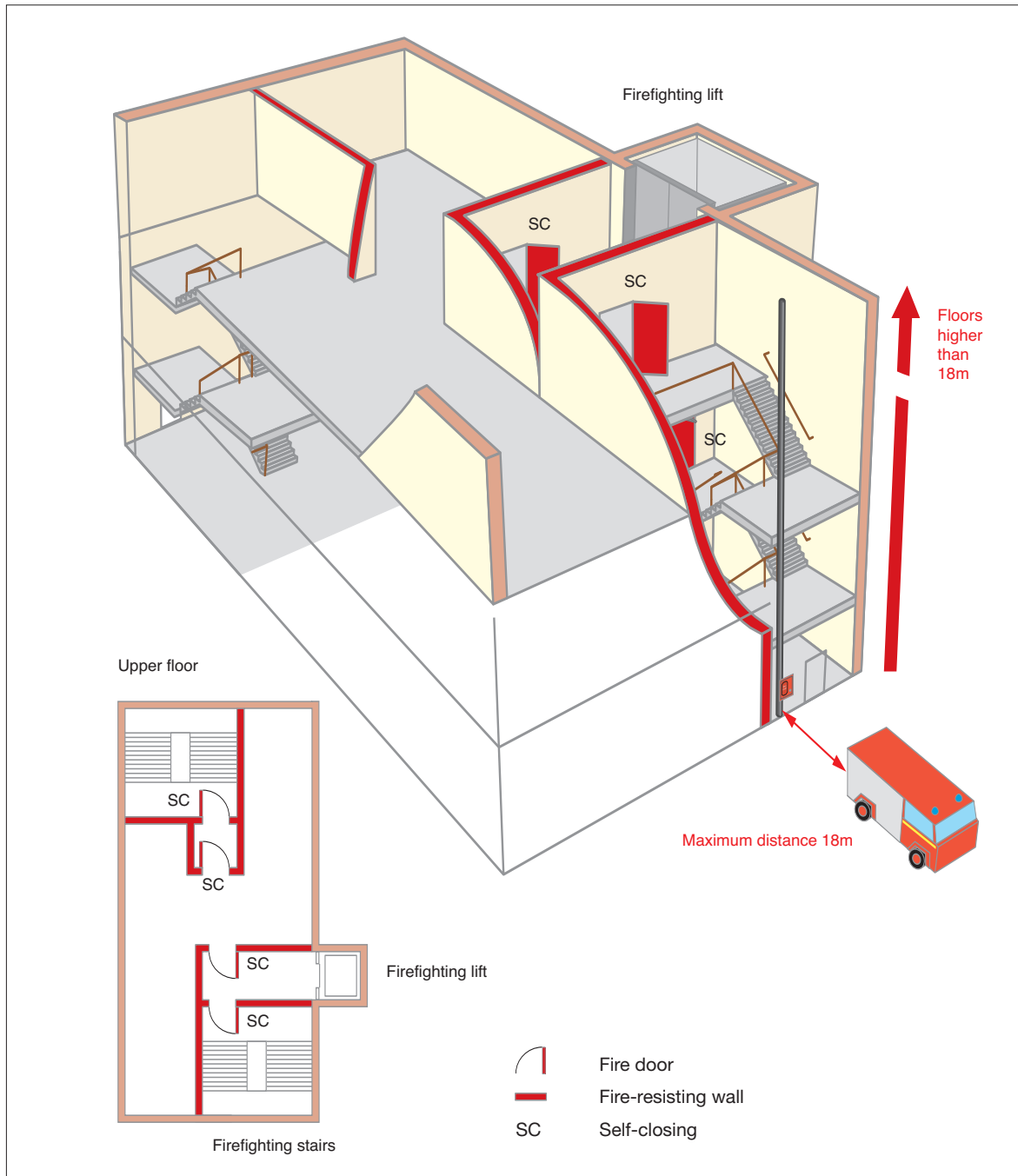

### Multi-storey buildings (or parts of buildings) with a single stairway

#### Two-storey, ground and one upper floor

In two-storey premises with a simple layout and a single stairway the arrangement in Figure 49 will generally be acceptable provided:

- The upper floor should accommodate no more than 60 people.
- The farthest point on each of the floors to the final exit is within the overall suggested travel distance for escape in one direction only (see Table 2 on page 71).

Figure 49: Two-storey, ground and one upper floor with a single stairway

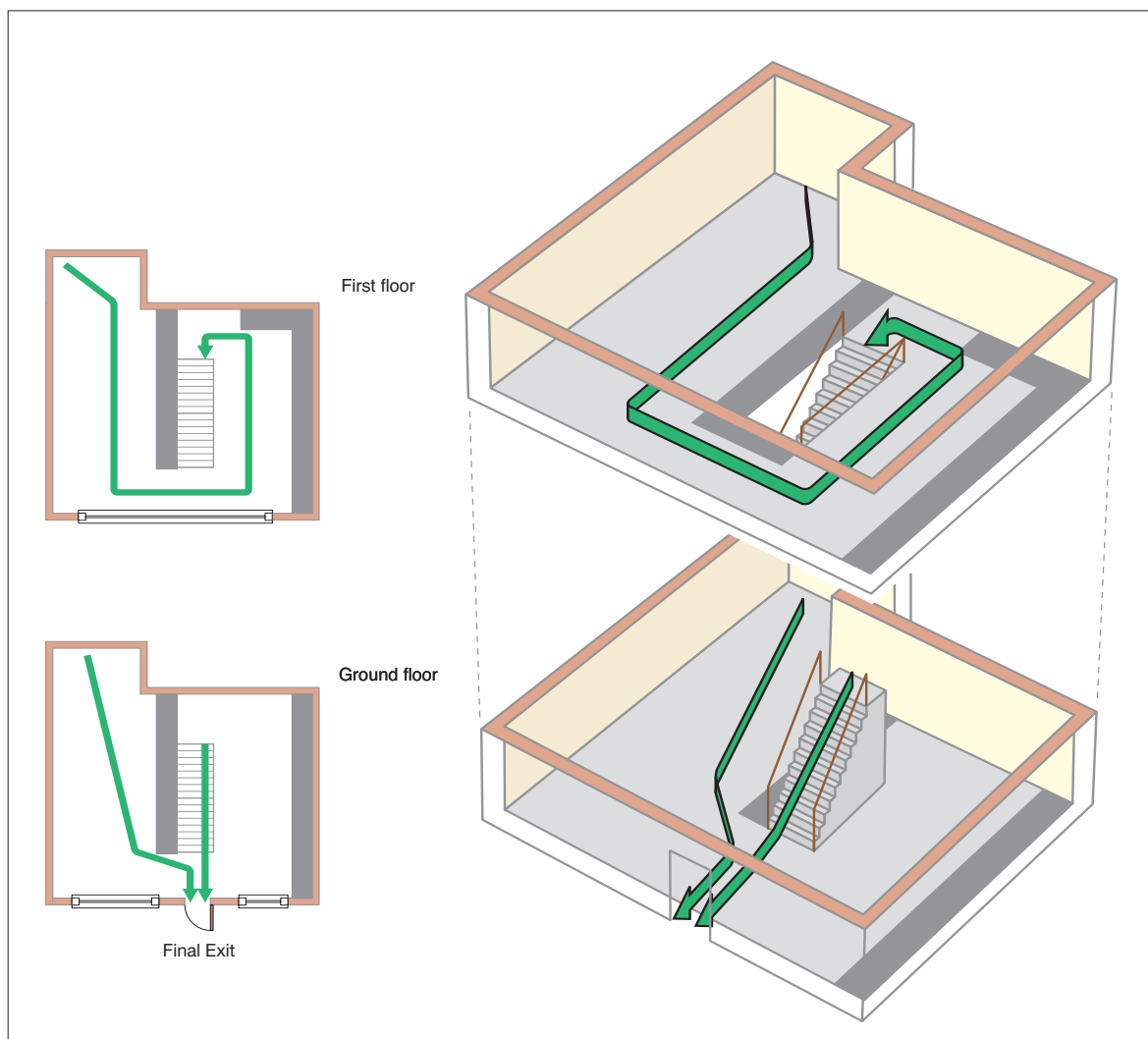

### Two-storey, basement and ground floor

In premises with a basement and a simple layout, an open stairway is acceptable as indicated in Figure 50 provided:

- The basement can accommodate no more than 60 people.
- The farthest point on each floor to the final exit is within the overall suggested travel distance (see Table 2 on page 71).

Figure 50: Two-storey, basement and ground floor with a single stairway

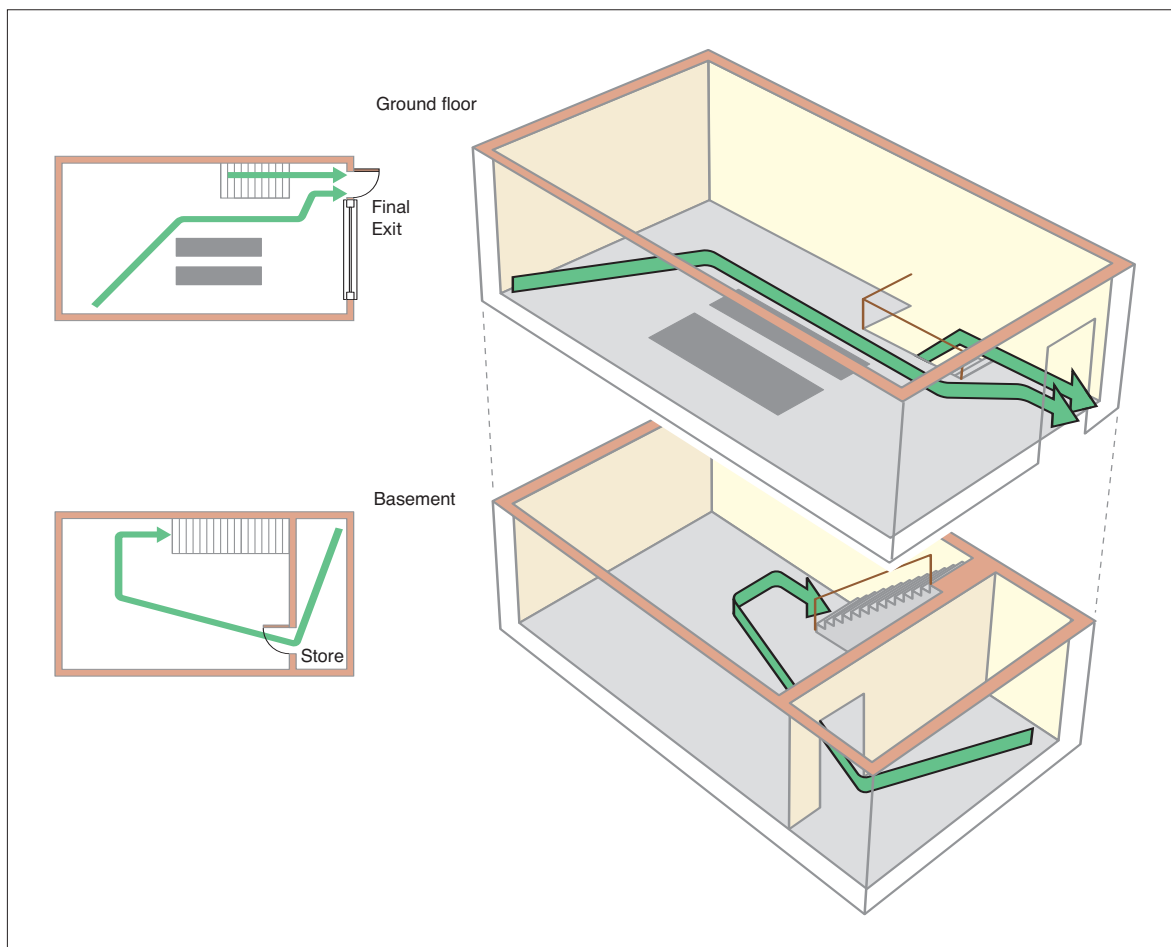

**Three-storey, small basement, ground and one upper floor, with a separate single stairway to each**

In premises with a ground floor, and a small basement and first floor each served by a separate single stairway, the layout in Figure 51 will be generally acceptable as long as the following apply:

- The basement should accommodate no more than 60 people.
- The first floor should accommodate no more than 60 people.

- The farthest point in the basement to the door to the nearest stairway is within the overall suggested travel distance (see Table 2 on page 71).
- The stairways from the basement to ground floor level is enclosed by fire-resisting construction and leads to a final exit.
- The farthest point on the first floor to the **final** exit is within the overall suggested travel distance.

Figure 51: Three-storey, small basement, ground and one upper floor, with a separate single stairway to each

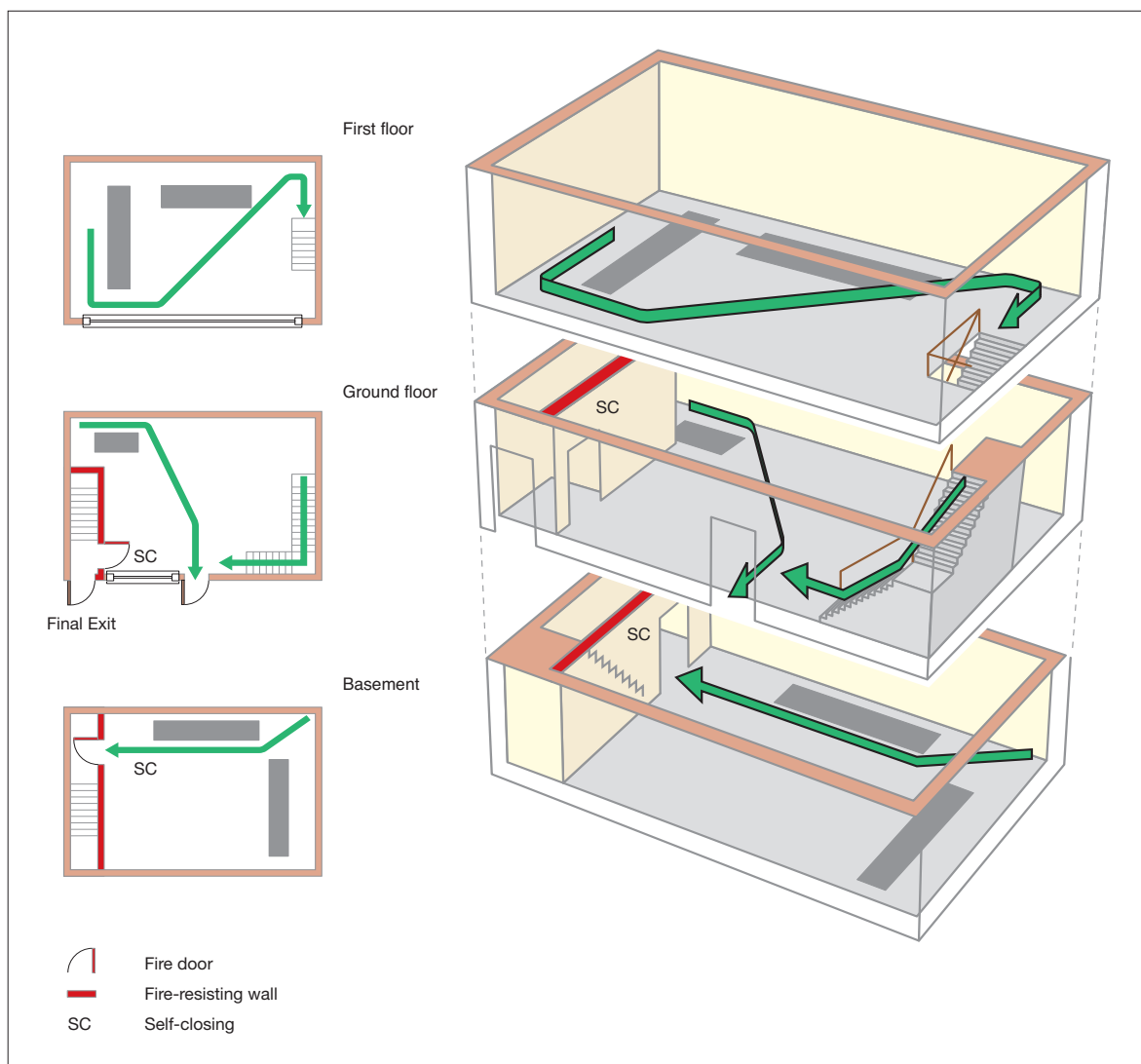

**Three-storey, basement, ground and one upper floor, with a single stairway**

In premises with a basement, ground and first floor, served by a single stairway, the layout shown in Figure 52 will be generally acceptable as long as the following apply:

- The basement should accommodate no more than 60 people.
- The first floor should accommodate no more than 60 people.
- To overcome the restriction of travel distance the stairway has been completely enclosed in 30-minute fire-resisting construction and all doors onto the stairway are self-closing fire doors.
- The farthest point on floor each to the storey exit is within the overall suggested travel distance (see Table 2 on page 71).
- Where the building incorporates a basement, any stairway from the basement is separated by a fire-resisting lobby or corridor between that basement and the protected stairway.

Figure 52: Three-storey, basement, ground and one upper floor, with a single stairway

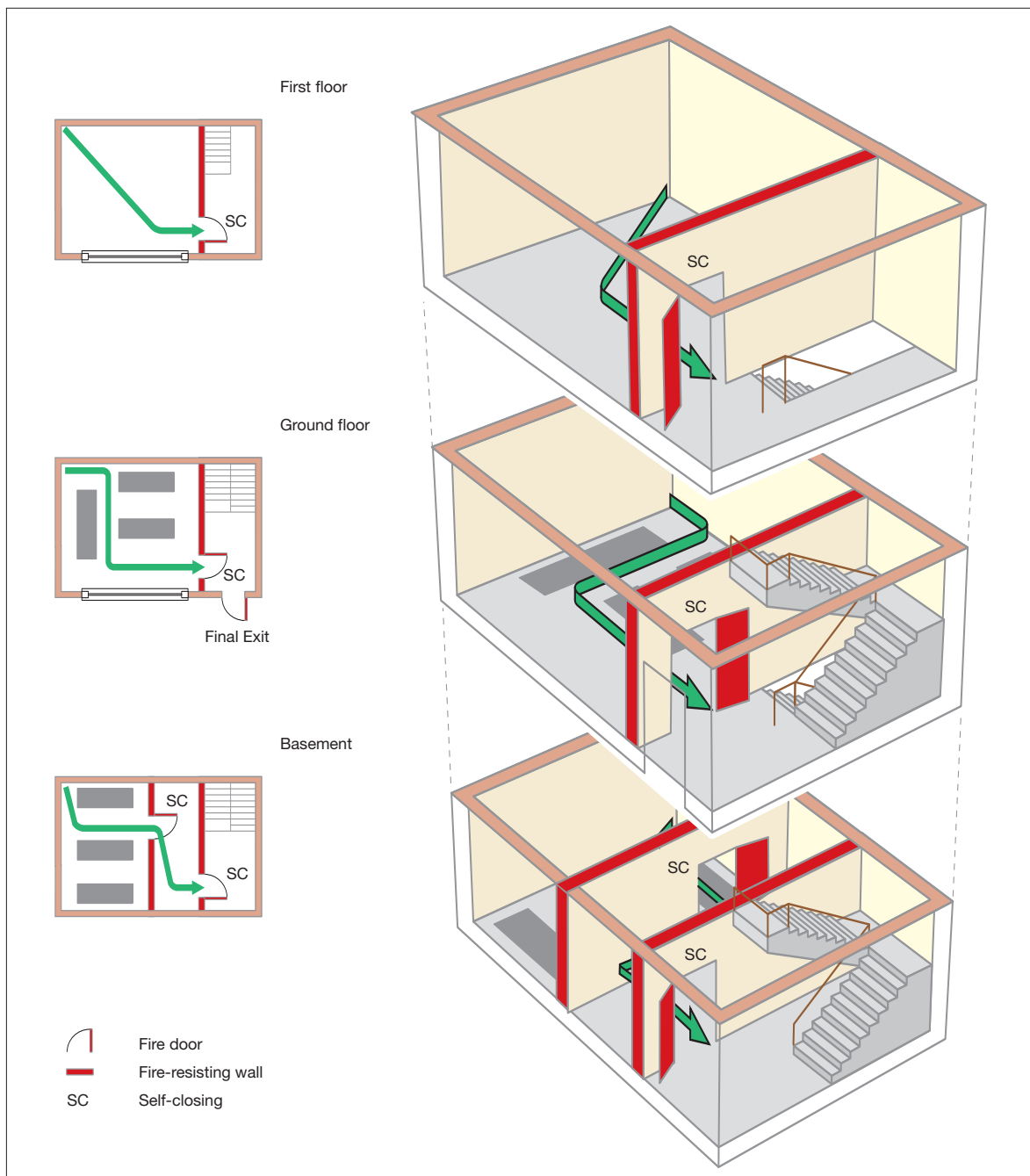

**Four storey, ground and up to three upper floors**

In premises with a ground floor and up to three upper floors served by a single stairway, it is important to understand that you are unlikely to be able to meet the suggested travel distance to a final exit (see Table 2 on page 71). In these circumstances it is necessary to protect the stairway by a fire-resisting enclosure as shown.

The layout shown in Figure 53 will be generally acceptable as long as the following apply:

- The upper floors should each accommodate no more than 60 people.
- The farthest point on all of the floors to the storey exit is within the overall suggested travel distance (see Table 2 on page 71).

Figure 53: Four storey, ground and up to three upper floors

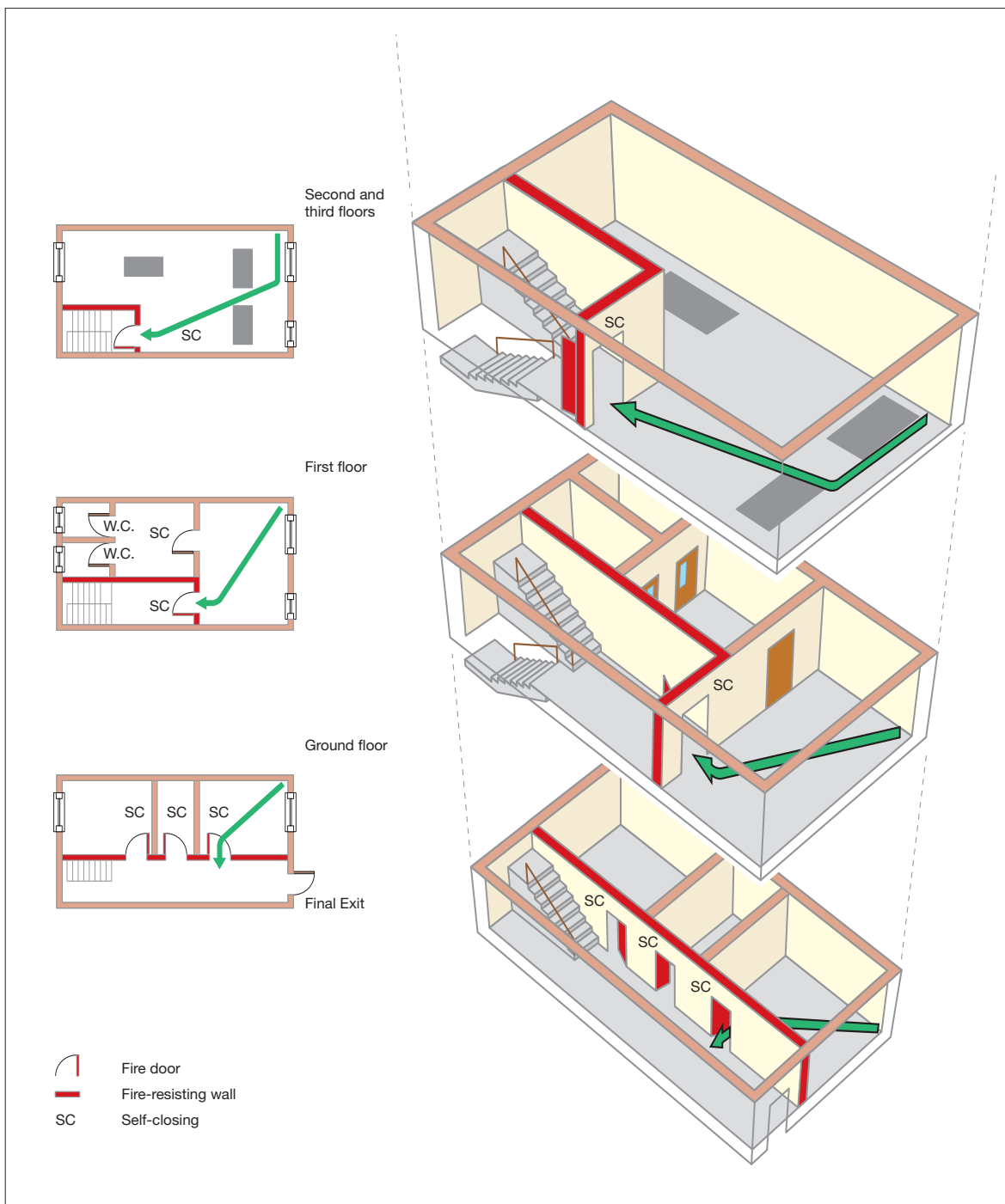

**Four storey, ground and up to three upper floors: higher risk premises**

In premises with higher risk areas (e.g. paint spraying activities) with a single stairway, to protect the escape route by preventing smoke from entering the stairway, a protected stairway with lobby or corridor approach between the stairway and all floors (other than the top floor) should be provided as shown.

The layout shown in Figure 54 will be generally acceptable as long as the following apply:

- The upper floors should each accommodate no more than 60 people.
- The farthest point on all of the floors to the lobbied storey exit is within the overall suggested travel distance (see Table 2 on page 71).
- When a protected lobby or corridor approach to the stairway is employed the travel distance is measured to the storey exit and not the door to the lobby or corridor.

Alternatively, automatic fire detection on all floors may be used instead of protected lobbies or corridors (see Figure 55); however, the stairway must still be protected.

Figure 54: Four storey, ground and up to three upper floors: higher risk premises – protected lobbies/corridors

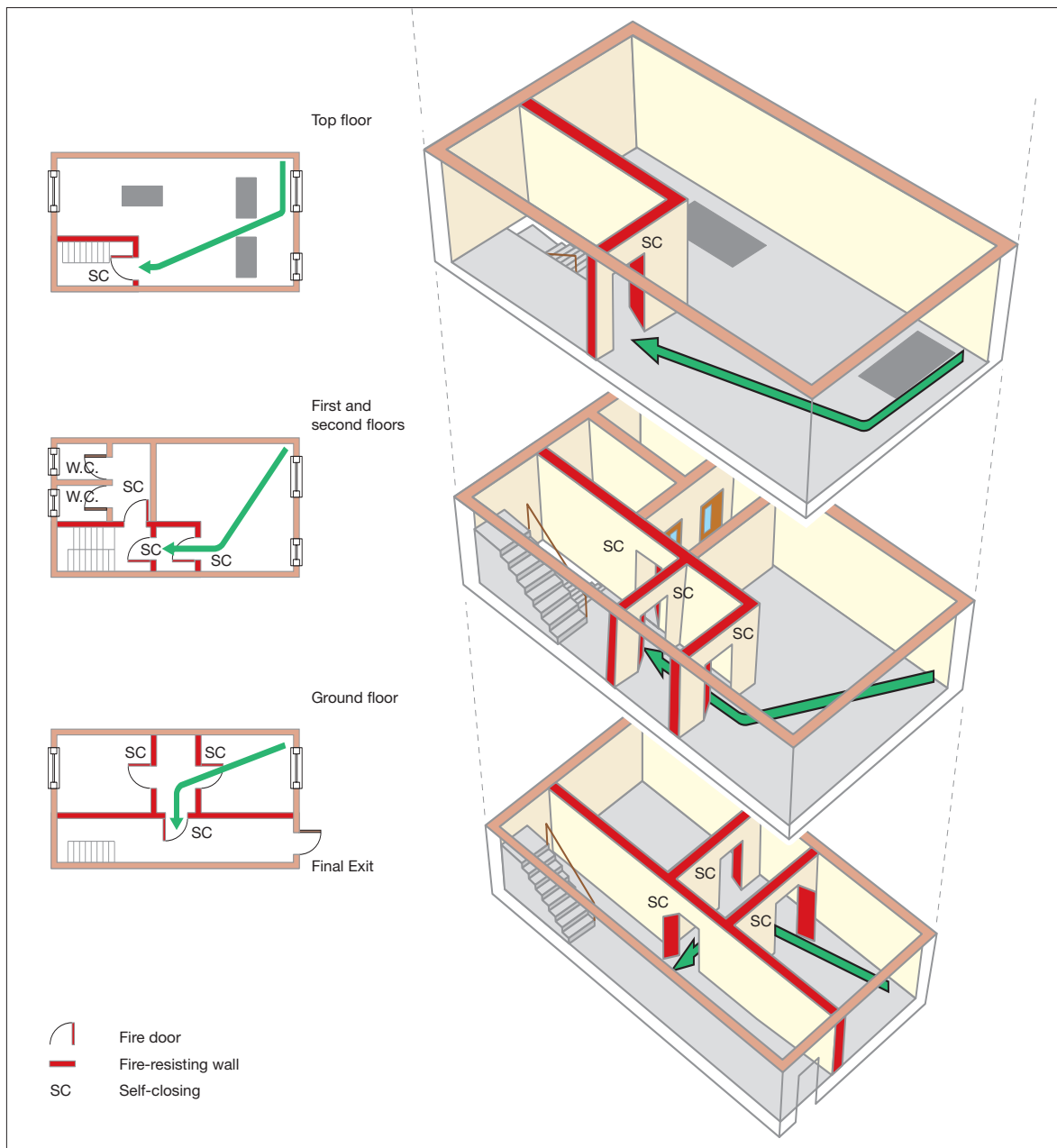
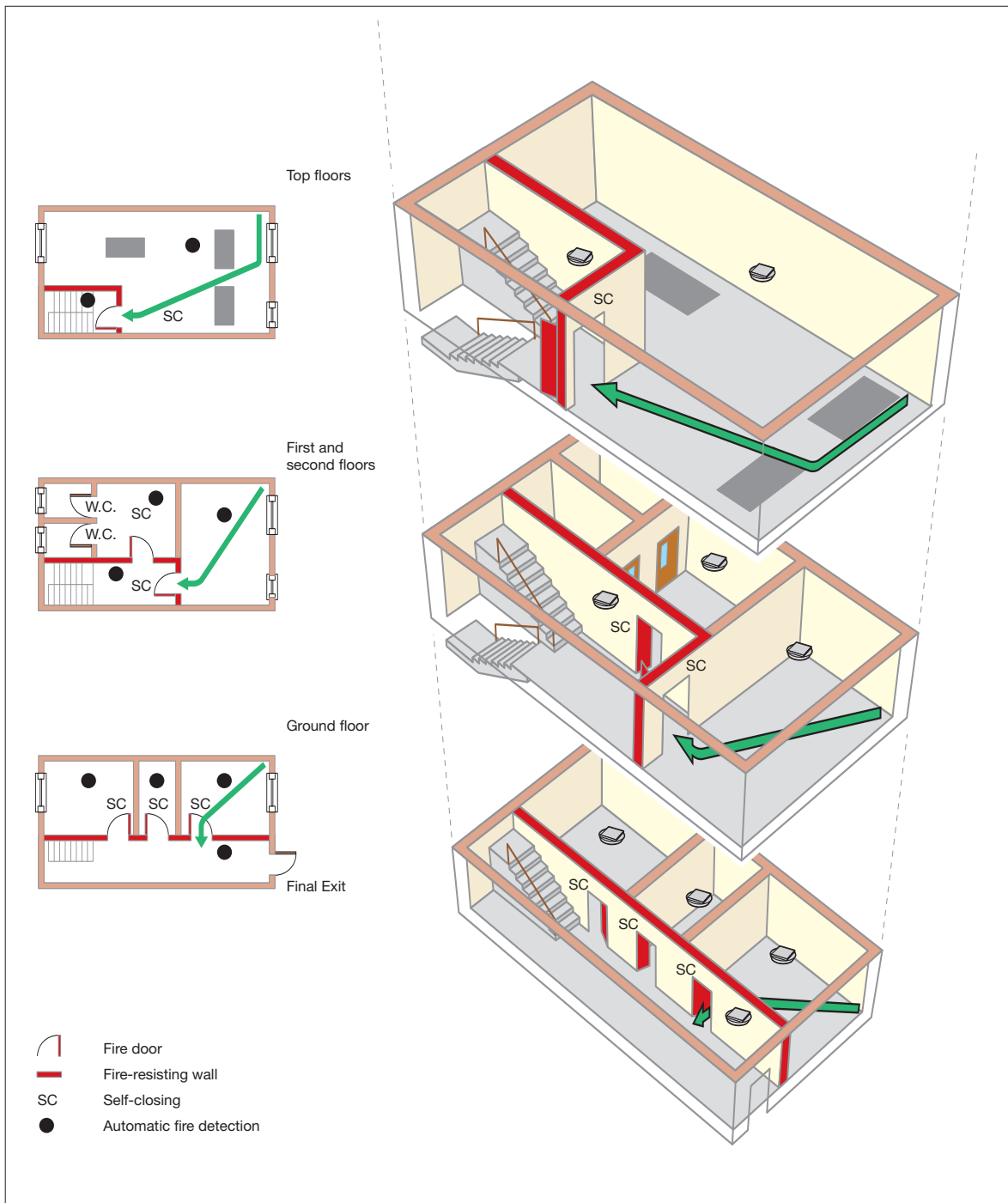



Figure 55: Four storey, ground and up to three upper floors: higher risk premises – protected with automatic fire detection



## Section 5 Further guidance on emergency escape lighting

The primary purpose of emergency escape lighting is to illuminate escape routes, but it also illuminates safety equipment.

The size and type of your premises and the risk to the occupants will determine the complexity of the emergency escape lighting required. In simple single storey premises where borrowed lighting or torches are not appropriate, single 'stand-alone' escape lighting units may be sufficient and these can sometimes be combined with exit or directional signs. The level of general illumination should not be significantly reduced by the sign.

In larger, more complex premises a more comprehensive system of fixed automatic escape lighting is likely to be needed. This will be particularly true in premises with extensive basements or where there are significant numbers of staff or members of the public.

In warehouses and large open-plan areas in factories, an efficient and effective method of illuminating escape routes in an emergency is by using spotlights. These are normally self-contained units consisting of a battery, switching mechanism and spotlights (see Figure 56) fitted to operate automatically on a circuit or mains failure.

These self-contained units can be suspended from roofs, structural steelwork such as columns or beams, substantial fixed high racking or attached to walls, etc. and are capable of illuminating escape routes easily. They should be located at high level and point downward.

*Figure 56: Self-contained spot lights*



You will have identified the escape routes when carrying out your fire risk assessment and need to ensure that they are all adequately lit. If there are escape routes that are not permanently illuminated by normal lighting, such as external stairs, then a switch, clearly marked 'Escape lighting', or some other means of switching on the lighting should be provided at the entry to that area/stairs.

An emergency escape lighting system should normally cover the following:

- each exit door;
- escape routes;
- intersections of corridors;
- outside each final exit and on external escape routes;
- emergency escape signs;
- stairways so that each flight receives adequate light;
- changes in floor level;
- windowless rooms and toilet accommodation exceeding 8m<sup>2</sup>;
- firefighting equipment;
- fire alarm call points;
- equipment that would need to be shut down in an emergency;
- lifts; and
- areas in premises greater than 60m<sup>2</sup>.

It is not necessary to provide individual lights (luminaires) for each item above, but there should be a sufficient overall level of light to allow them to be visible and usable.

Emergency escape lighting can be both 'maintained', i.e. on all the time, or 'non-maintained' which only operates when the normal lighting fails. Systems or individual lighting units (luminaires) are designed to operate for durations of between one and three hours. In practice, the three-hour design is the most popular and can help with maintaining limited continued use of your premises during a power failure (other than in an emergency situation).

Figure 57: Luminaires

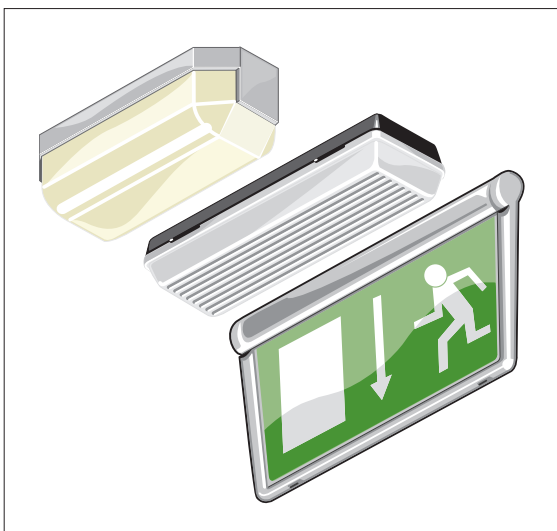

Emergency escape lighting (luminaires) can be stand-alone dedicated units or incorporated into normal light fittings. There are highly decorative versions of these for those areas that demand aesthetically pleasing fixtures. Power supplies can be rechargeable batteries integral to each unit, a central battery bank or an automatic start generator.

To complement emergency escape lighting, people, especially those unfamiliar with the premises, can be helped to identify exit routes by the use of way-guidance equipment. Way-guidance systems usually comprise photo-luminescent material, lines of LEDs, or strips of miniature incandescent lamps, forming a continuous marked escape route at lower level (Figure 58). These systems have proved particularly effective when people have to escape through smoke, and for partially-sighted people. They can be particularly useful in premises where they can provide marked routes on floors and in multi-storey premises they can direct people to escape routes which are seldom used.

If you decide that you need to install emergency escape lighting or to modify your existing system, any work should be carried out by a competent person in accordance with the appropriate standards. Further guidance is given in BS 5266-1<sup>28</sup> and BS 5266-8.<sup>27</sup>

Figure 58: A 'way-guidance' system

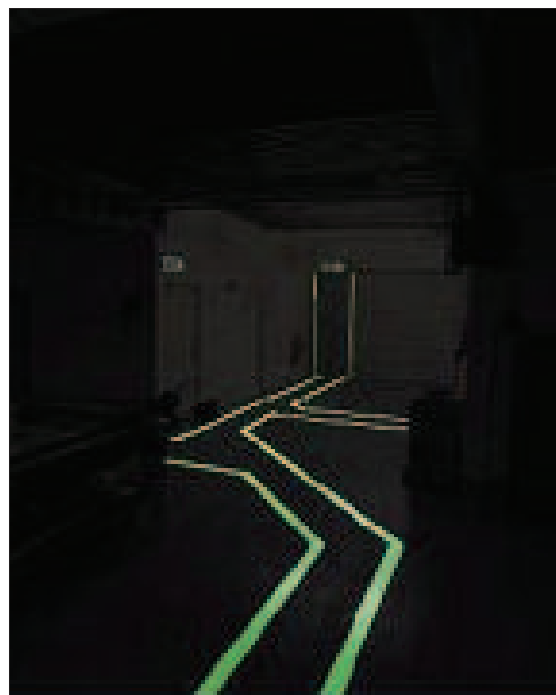

### Maintenance and testing of emergency escape lighting

All emergency escape lighting systems should be regularly tested and properly maintained to an appropriate standard. Most existing systems will need to be manually tested. However, some modern systems have self-testing facilities that reduce routine checks to a minimum.

Depending on your type of installation you should be able to carry out most of the routine tests yourself. The test method will vary. If you are not sure how to carry out these tests you should contact your supplier or other competent person.

Figure 59: A test key

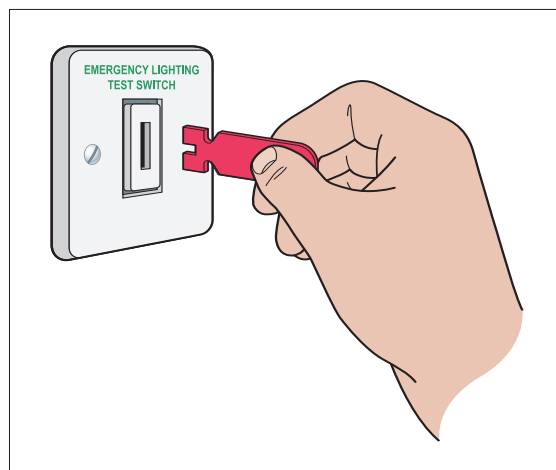

Test facilities often take the form of a 'fishtail' key (Figure 59) inserted in a special switch either near the main fuse board or adjacent to relevant light switches.

Typically, testing would include:

- a daily visual check of any central controls;
- a monthly function test by operating the test facility for a period sufficient to ensure that each emergency lamp illuminates; and
- an annual full discharge test.

Particular care needs to be taken following a full discharge test. Batteries typically take 24 hours to re-charge and the premises should not be re-occupied until the emergency lighting system is fully functioning unless alternative arrangements have been made. See BS 5266-8<sup>27</sup> and BS 5266-1<sup>28</sup> for more information.

It is good practice to keep a record of tests.

## Section 6 Further guidance on signs and notices

### Escape signs

In simple premises, a few signs indicating the alternative exit(s) might be all that is needed. In more complex premises, a series of signs directing people along the escape routes towards the final exit may be needed.

Many people with poor vision retain some sight and are able to recognise changing or contrasting colour to provide them with visual clues when moving around a building.\* It may be sufficient to paint any columns and walls in a contrasting colour and to highlight changes in level by, for example, making the nosing to step and stair treads a contrasting colour (see BS 8300<sup>14</sup> for further guidance).

For people with no sight, a well-managed 'buddy system', continuous handrails, a sound localisation system (which helps people to move towards an alert sound) or the installation of more tactile aids may be appropriate.

Exit signs should be clearly visible whenever the public, staff and contractors are present.

### Positioning of escape signs

The presence of other signs in factories and warehouses (such as staff notices or operating instructions) can distract attention from, or obscure the visibility of, escape signs. This could affect people's ability to see and understand escape signs, particularly if there is a fire evacuation. Always ensure that escape signs are not overwhelmed.

Escape signs should meet the following criteria:

- They should provide clear, unambiguous information to enable people to safely leave a building in an emergency.
- Every escape route sign should, where necessary, incorporate, or be accompanied by, a directional arrow. Arrows should not be used on their own.
- If the escape route to the nearest exit is not obvious then it should be indicated by a sign(s).

\* The Royal National Institute of the Blind estimates that only about 4% of visually impaired people are totally blind.

- Signs should be positioned so that a person escaping will always have the next escape route sign in sight.
- Escape signs should be fixed above the door in the direction of escape and not be fixed to doors, as they will not be visible if the door is open.
- Signs mounted above doors should be at a height of between 2.0m and 2.5m above the floor.
- Signs on walls should be mounted between 1.7m and 2.0m above the floor.
- Mounting heights greater than 2.5m may be used for hanging signs, e.g. in large open spaces or for operational reasons, but care should be taken to ensure that such signs are both conspicuous and legible. In such case larger signs may be necessary.
- Signs should be sited at the same height throughout the escape route, so far as is reasonably practicable.

### Escape sign design

For a sign to comply with signs and signals regulations it must be pictographic (see Figures 60 and 61). The pictogram can be supplemented by text if this is considered necessary to make the sign easily understood (BS-type sign), but you must not have a fire safety sign that uses only text. Either type of sign can be used but different types should not be mixed.

Appropriate signs should take into account the needs of those who may need to use them.

The legibility of escape signs is determined by the size of the sign, its level of illumination and the distance over which it is viewed. The use of signs within the same premises should follow a consistent design pattern or scheme. You should not rely on a few oversized signs which may encourage people to travel to a particular escape route when other more appropriate routes should be used.

In multi-occupied premises, co-operation between the respective 'responsible persons' should be sought to ensure that, as far as possible, all signs in the building conform to a single pattern or scheme.

Figure 60: BS-type sign



Figure 61: Euro sign

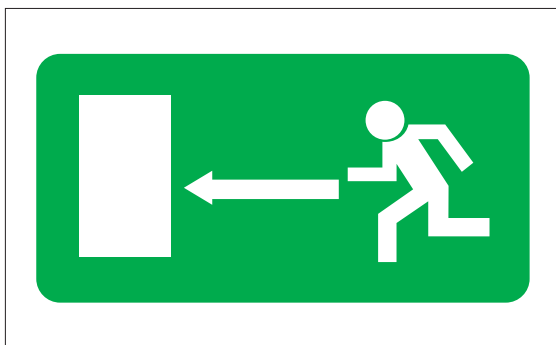

### Other safety signs and notices

A number of other mandatory signs such as 'Fire action' notices may also be necessary.

Fire doors that have been fitted with self-closing devices should be labelled 'Fire door – keep shut' (Figure 62) on both sides. Fire-resisting doors to cupboards, stores and service ducts that are not self-closing because they are routinely kept locked should be labelled 'Fire door – keep locked' on the outside.

Figure 62: Fire door 'keep shut' notice



Signs should indicate non-automatic fire safety equipment if there is any doubt about its location, e.g. fire extinguishers that are kept in cabinets or in recesses.

A notice with the words 'Push bar to open' should be permanently displayed immediately above the push-bar on all doors fitted with a panic bolt or panic latch.

A notice with the words 'Fire escape – keep clear' should be permanently displayed at about eye level on the external face of all doors which are provided as a means of escape in case of fire and which, because they are not normally used, may become obstructed.

### Staff notices

In simple premises where there are a limited number of escape routes, it may be reasonable to provide staff with verbal reminders of what they need to do if there is a fire. In some premises, you could consider providing a short written statement that could, for example, be delivered with staff pay slips every six months.

In multi-occupied, larger and more complex premises or where there is a high turnover of staff, a more considered approach for staff notices and instructions will be necessary. As well as positioning the fire instructions notice on escape routes adjacent to fire break-glass call points (Figure 63), put them where staff frequently assemble in the premises, e.g. the canteen and locker rooms.

Figure 63: Fire action notice

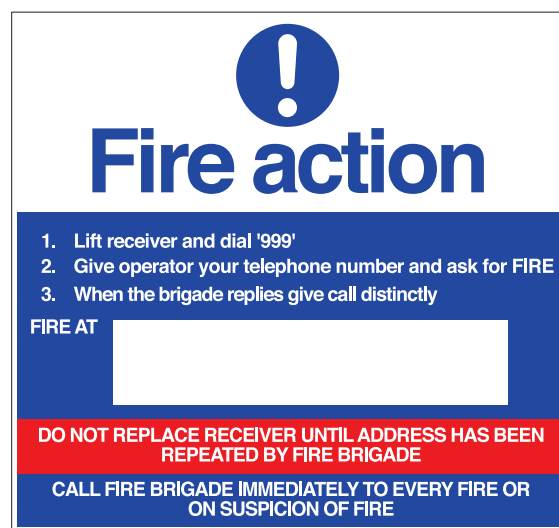

If your premises are routinely expected to accommodate people whose first language is not English you may need to consider providing instructions in more than one language. The interpretation should always convey an identical message.

### **Illumination**

All signs and notices will need illumination to ensure they are conspicuous and legible. There are a number of options available to achieve this, such as:

- external illumination; and
- internal illumination.

The supplier or other competent person can give you further advice.

Signs or notices of the photo-luminescent type, i.e. where the active material making up the luminous parts of such signs or notices needs a period of exposure to light before they become visible in darkness (but get fainter with time), are not a substitute for appropriate emergency lighting and should only be used where other forms of illumination are present.

### **Further guidance**

Detailed guidance on fire safety signs can be found in BS 5499-4<sup>30</sup> and BS 5499-5.<sup>74</sup> Published guidance<sup>5,6</sup> on compliance with health and safety legislation on signs is also available. Guidance about the use of photo-luminescent fire safety signs and notices can be found in BS 5266-6.<sup>73</sup>

# Section 7 Further guidance on recording, planning, informing, instructing and training

## 7.1 Fire safety records

Keeping up-to-date records of your fire risk assessment can help you effectively manage the fire strategy for your premises and demonstrate how you are complying with fire safety law.

Even if you do not have to record the fire risk assessment, it can be helpful to keep a record of any co-operation and exchange of information made between employers and other responsible people for future reference.

In larger and more complex premises, it is best to keep a dedicated record of all maintenance of fire-protection equipment and training. There is no one 'correct' format specified for this. Suitable record books are available from trade associations and may also be available from your local enforcing authority.

In all cases the quality of records may also be regarded as a good indicator of the overall quality of the safety management structure.

Your records should be kept in a specified place on the premises (for example, in the management's office), and should include:

- details of any significant findings from the fire risk assessment and any action taken (see Part 1, Section 4.1);
- testing and checking of escape routes, including final exit locking mechanisms, such as panic devices, emergency exit devices and any electromagnetic devices;
- testing of fire-warning systems, including weekly alarm tests and periodic maintenance by a competent person;
- recording of false alarms;
- testing and maintenance of emergency lighting systems;
- testing and maintenance of fire extinguishers, hose reels and fire blankets, etc.;
- if appropriate, testing and maintenance of other fire safety equipment such as fire-

suppression systems and smoke control systems;

- recording and training of relevant people and fire evacuation drills;
- planning, organising, policy and implementation, monitoring, audit and review;
- maintenance and audit of any systems that are provided to help the fire and rescue service;
- the arrangements in a large multi-occupied building for a co-ordinated emergency plan or overall control of the actions you or your staff should take if there is a fire; and
- all alterations, tests, repairs and maintenance of fire safety systems, including passive systems such as fire doors.

Other issues that you may wish to record include:

- the competence, qualifications and status of the persons responsible for carrying out inspections and tests;
- the results of periodic safety audits, reviews, inspections and tests, and any remedial action taken;
- all incidents and circumstances which had the potential to cause accidents and monitor subsequent remedial actions; and
- a record of the building use, the fire prevention and protection measures in place and high-risk areas.

You should ensure that no other management decisions or policies compromise safety.

Your documentation should be available for inspection by representatives of the enforcing authority.

More detailed advice is given in BS 5588-12.<sup>52</sup>

Figure 64 is an example of how to record some individual stages of the process in more detail. A blank version of this form is provided in Appendix A2.



Figure 64: Example record of significant findings

Risk Assessment – Record of significant findings			
Risk assessment for		Assessment undertaken by	
Company	Acme Fine Engineering	Date	02/02/2006
Address	Unit 2, Ferry Estate	Completed by	J Brown
	New Town CD12 4AB	Signature	J Brown
Sheet number	Floor/area	Use	
One	Ground floor production area	Workshop	
Step 1 – Identify fire hazards			
Sources of ignition	Sources of fuel	Sources of oxygen	
Electrical plant and equipment Soldering station Radiant electrical heaters Microwave/kettle in tea bay	Plastic electrical casings Cable and various small components Packaging Degreasing solvent	No additional sources	
Step 2 – People at risk			
5 full time staff members 2 part time staff members	4 sales representatives - occasional access only	1 cleaner 2 office clerks	
Step 3 – Evaluate, remove, reduce and protect from risk			
<b>(3.1) Evaluate the risk of the fire occurring</b>	Degreasing work station in close proximity to soldering work station Workshop routinely used to store plastic components Tea bay untidy and cluttered. Equipment appears to be in poor condition Radiant heaters in proximity to various combustible materials		
<b>(3.2) Evaluate the risk to people from a fire starting in the premises</b>	Predominantly open plan so fire in workshop area quickly evident Fire in rear store could go undetected Fire in workshop could effect first floor office		
<b>(3.3) Remove and reduce the hazards that may cause a fire</b>	Resite degreasing area remote from soldering area Limit quantity of degreasing agent in workshop to one 10 litre tin (about one days supply) Plastic components to be stored in storeroom Packaging material to be placed in secure store to rear of premises Replace radiant heaters with suitable convection heaters Tea bay to be moved to first floor and monitored by cleaner Replace kettle and microwave oven		
<b>(3.4) Remove and reduce the risks to people from a fire</b>	The current fire precaution measures (refer to floor plan A) have been assessed in view of the findings recorded above. They are considered adequate with the following exceptions <u>Additional measures considered necessary</u> Provide automatic fire detection to rear store Fire door protecting staircase to 1st floor office requires new self closer Provide additional fire alarm sounder to first floor - currently not sufficiently audible Fire extinguisher require maintenance Introduce periodic staff refresher training and programme in fire drills Replace damaged fire exit sign above rear exit Provide flammable liquid bin in rear store		
Assessment review			
Assessment review date	Completed by	Signature	
<b>Review outcome (where substantial changes have occurred a new record sheet should be used)</b>			

## Notes:

- (1) The risk assessment record significant findings should refer to other plans, records or other documents as necessary.
- (2) The information in this record should assist you to develop an emergency plan; coordinate measures with other 'responsible persons' in the building; and to inform and train staff and inform other relevant persons.

In premises with 'engineered fire safety strategies', a fire policy manual should be provided in addition to any other records. Guidance on the structure of fire engineering policy manuals is given in BS 7974-0 Section 5: Reporting and presentation.<sup>31</sup>

### Fire safety audit

A fire safety audit can be used alongside your fire risk assessment to identify what fire safety provisions exist in your premises.

When carrying out a review of your fire safety risk assessment, a pre-planned audit can quickly identify if there have been any significant changes which may affect the fire safety systems and highlight whether a full fire risk assessment is necessary.

### Plans and specifications

Plans and specifications can be used to assist understanding of a fire risk assessment or emergency plan. Even where not needed for this purpose they can help you and your staff keep your fire risk assessment and emergency plan under review and help the fire and rescue service in the event of fire. Any symbols used should be shown on a key. Plans and specifications could include the following:

- essential structural features such as the layout of function rooms, escape doors, wall partitions, corridors, stairways, etc. (including any fire-resisting structure and self-closing fire doors provided to protect the escape routes);
- location of refuges and lifts that have been designated suitable for use by disabled people and others who may need assistance to escape in case of a fire;
- methods for fighting fire (details of the number, type and location of the firefighting equipment);
- location of manually-operated fire alarm call points and control equipment for fire alarms;
- location of any control rooms and fire staff posts;
- location of any emergency lighting equipment and the exit route signs;
- location of any high-risk areas, equipment or process that must be immediately shut down by staff on hearing the fire alarm;
- location of any automatic firefighting systems, risers and sprinkler control valves;

- location of the main electrical supply switch, the main water shut-off valve and, where appropriate, the main gas or oil shut-off valves; and
- plans and specifications relating to all recent constructions.

This information should be passed on to any later users or owners of the premises.

## 7.2 Emergency plans

### Emergency plan and contingency plans

Your emergency plan should be appropriate to your premises and could include:

- how people will be warned if there is a fire;
- what staff should do if they discover a fire;
- how the evacuation of the premises should be carried out;
- where people should assemble after they have left the premises and procedures for checking whether the premises have been evacuated;
- identification of key escape routes, how people can gain access to them and escape from them to a place of total safety;
- arrangements for fighting the fire;
- the duties and identity of staff who have specific responsibilities if there is a fire;
- arrangements for the safe evacuation of people identified as being especially at risk, such as young persons, those with disabilities or lone workers;
- any machines/processes/appliances/power supplies that need to be stopped or isolated if there is a fire;
- specific arrangements, if necessary, for high fire-risk areas;
- contingency plans for when life safety systems, such as evacuation lifts, fire-detection and warning systems, sprinklers or smoke control systems are out of order;
- how the fire and rescue service and any other necessary services will be called and who will be responsible for doing this;
- procedures for meeting the fire and rescue service on their arrival and notifying them of any special risks, e.g. the location of highly flammable materials; and

- what training employees need and the arrangements for ensuring that this training is given.

As part of your emergency plan it is good practice to prepare post-incident plans for dealing with situations that might arise such as those involving:

- young persons;
- people with personal belongings (especially valuables) still in the building;
- getting people away from the building (e.g. to transport); and
- inclement weather.

You should therefore prepare contingency plans to determine specific actions and/or the mobilisation of specialist resources.

The emergency services may prepare an emergency procedure plan (or major incident plan) for dealing with a major incident (for example, an explosion, toxic release or large fire). Your contingency plans and the emergency procedure plan should be compatible. In such cases consultation should therefore take place between yourself and the police, fire and ambulance services, the local health authority and local authority, in order to produce an agreed plan of action, including access for emergency vehicles, for all foreseeable incidents.

Guidance on developing health and safety management policy has been published by the HSE.<sup>32</sup>

### 7.3 Information, instruction, co-operation and co-ordination

#### Supplying information

You must provide easily understandable information to employees, the parents of children you may employ, and to employers of other persons working in your premises about the measures in place to ensure a safe escape from the building and how they will operate, for example:

- any significant risks to staff and other relevant persons that have been identified in your fire risk assessment or any similar assessment carried out by another user and responsible person in the building;
- the fire prevention and protection measures and procedures in your premises and where they impact on staff and other relevant persons in the building;
- the procedures for fighting a fire in the premises; and
- the identity of people who have been nominated with specific responsibilities in the building.

Even if you do not have to record the fire risk assessment, it would be helpful to keep a record of any co-operation and exchange of information made between employers and other responsible people for future reference.

You need to ensure that all staff and, where necessary, other relevant persons in the building, receive appropriate information in a way that can be easily understood. This might include any special instructions to particular people who have been allocated a specific task, such as shutting down equipment or guiding people to the nearest exit.

#### Duties of employees to give information

Employees also have a duty to take reasonable care for their own safety and that of other people who may be affected by their activities. This includes the need for them to inform their employer of any activity that they consider would present a serious and immediate danger to their own safety and that of others.

#### Dangerous substances

HSE publishes guidance<sup>8</sup> about specific substances where appropriate information may need to be provided. If any of these, or any other substance that is not included but nevertheless presents more than a slight risk, is present in your premises, then you must provide such information to staff and others, specifically you must:

- name the substance and the risks associated with it, e.g. how to safely use or store the product to avoid creating highly flammable vapours or explosive atmospheres;
- identify any legislative provisions that may be associated with the substance;
- allow employees access to the hazardous substances safety data sheet; and
- inform the local fire and rescue service where dangerous substances are present on the premises.

#### Case study

A few boxes of sodium chlorate-based weedkiller, or a few litres of flammable varnish, are unlikely to need anything other than basic precautions such as a warning sign on the room or container in which they are stored. However, the storage and/or use of sizeable quantities of polystyrene pellets for packaging or significant quantities of highly flammable liquids stored in a warehouse will require more comprehensive information and notification to the fire and rescue service.

#### Information to the emergency services

In addition to providing information to the fire and rescue service when dangerous substances are present in sufficient quantities to pose an enhanced risk, it will also be helpful to inform them of any short term changes that might have an impact on their firefighting activities; e.g. in the event of temporary loss of a firefighting facility and temporary alterations.

Procedures should also include meeting and briefing the fire and rescue service when they arrive.

#### Case study

If the firefighting lift in a multi-storey premises becomes defective, this should be brought to the attention of the fire and rescue service. Being unable to use this facility to tackle a fire on the upper floors might have a serious effect on the ability of firefighters to begin operations as quickly as planned. The information supplied will enable the emergency services to make adjustments to the level of the emergency response. However the responsible person should ensure that the defect is corrected as soon as possible and the fire and rescue service notified.

#### Instruction

You will need to carefully consider the type of instructions to staff and other people working in your premises. Written instructions must be concise, comprehensible and relevant and therefore must be reviewed and updated as

new working practices and hazardous substances are introduced.

Inclusive access and employment policies mean that people with learning difficulties may now be present in a range of premises and your fire risk assessment should consider whether further instruction or guidance is necessary to ensure that your evacuation strategy is appropriate and understood by everyone.

Instructions will need to be given to people delegated to carry out particular tasks, for example:

- removing additional security, bolts, bars or chains on final exit doors before the start of business to ensure that escape routes are accessible;
- daily, weekly, quarterly and yearly checks on the range of fire safety measures (in larger premises some of the work may be contracted out to a specialist company);
- safety considerations when closing down the premises at the end of the day, e.g. removing rubbish, ensuring enough exits are available for people that remain and closing fire doors and shutters;
- leaving hazardous substances in a safe condition when evacuating the building;
- the safe storage of hazardous substances at the end of the working day; and
- ensuring everyone in large organisations with many buildings within a curtilage and a security zone know how to use internal emergency telephones.

Specific instructions may be needed about:

- how staff will help members of the public/visitors to leave the building;
- 'sweeping' of the factory or warehouse floor by staff to guide people to the nearest exit when the fire alarm sounds;
- designating particular areas of a factory or warehouse for supervisors to check that no one remains inside;
- calling the emergency services;
- carrying out evacuation roll calls;
- taking charge at the assembly area;
- meeting and directing fire engines; and
- cover arrangements when nominated people are on leave.

### Co-operation and co-ordination

Where you share premises with others (this includes people who are self-employed or in partnership), each responsible person, i.e. each employer, owner or other person who has control over any part of the premises, will need to co-operate and co-ordinate the findings of their separate fire risk assessments to ensure the fire precautions and protection measures are effective throughout the building. This could include:

- co-ordinating an emergency plan (see Section 7.2 for features of an emergency plan);
- identifying the nature of any risks and how they may affect others in or about the premises;
- identifying any fire-prevention and protection measures;
- identifying any measures to mitigate the effects of a fire; and
- arranging any contacts with external emergency services and calling the fire and rescue services.

#### Case study

Company A stores a wide range of timber products including fence panels, garden sheds and timber decking, and also rents space to Company B. Company A's premises are in the open air where significant stockpiles of timber fencing are stored on 8m-high steel racking around the boundary. Should a fire start there is a significant risk that it will spread to the other premises, endangering people in both premises and in the immediate vicinity. The responsible person (Company A) should ensure that there is enough space between stacks of timber products and the boundary to ensure as far as possible that any fire is confined to the stack and would not spread and endanger other people. To do this, companies A and B will need to co-operate and co-ordinate as necessary.

## 7.4 Fire safety training

### Staff training

The actions of staff if there is a fire are likely to be crucial to their safety and that of other people in the premises. All staff should receive basic fire safety induction training and attend refresher sessions at pre-determined intervals.

You should ensure that all staff and contractors are told about the emergency plan and are shown the escape routes.

The training should take account of the findings of the fire risk assessment and be easily understood by all those attending. It should include the role that those members of staff will be expected to carry out if a fire occurs. This may vary in large premises, with some staff being appointed as fire marshals or being given some other particular role for which additional training will be required.

In addition to the guidance given in Part 1, Step 4.4, as a minimum all staff should receive training about:

- the items listed in your emergency plan;
- the importance of fire doors and other basic fire-prevention measures;
- where relevant, the appropriate use of firefighting equipment;
- the importance of reporting to the assembly area;
- exit routes and the operation of exit devices, including physically walking these routes;
- general matters such as permitted smoking areas or restrictions on cooking other than in designated areas; and
- assisting disabled persons where necessary.

Training is necessary:

- when staff start employment or are transferred into the premises;
- when changes have been made to the emergency plan and the preventive and protective measures;
- where working practices and processes or people's responsibilities change;
- to take account of any changed risks to the safety of staff or other relevant persons;
- to ensure that staff know what they have to do to safeguard themselves and others on the premises;
- where staff are expected to assist disabled persons; and
- if a member of staff may take on the role of duty manager.

Training should be repeated as often as necessary and should take place during working hours.

Whatever training you decide is necessary to support your fire safety strategy and emergency plan, it should be verifiable.

Enforcing authorities may want to examine records as evidence that adequate training has been given.

### **Fire marshals**

Staff expected to undertake the role of fire marshals (often called fire wardens) would require more comprehensive training. Their role may include:

- helping any members of the public, visitors and/or disabled persons leave the premises;
- checking designated areas to ensure everyone has left;
- using firefighting equipment if safe to do so;
- liaising with the fire and rescue service on arrival;
- shutting down vital or dangerous equipment; and
- performing a supervisory/managing role in any fire situation.

Training for this role may include:

- detailed knowledge of the fire safety strategy of the premises;
- awareness of human behaviour in fires;
- how to encourage others to use the most appropriate escape route;
- how to search safely and recognise areas that are unsafe to enter;
- the difficulties that some people, particularly if disabled, may have in escaping and any special evacuation arrangements that have been pre-planned;
- additional training in the use of firefighting equipment;
- an understanding of the purpose of any fixed firefighting equipment such as sprinklers or gas flooding systems; and
- reporting of faults, incidents and near misses.

### **Fire drills**

Once the emergency plan has been developed and training given, you will need to evaluate its effectiveness. The best way to do this is to perform a fire drill. This should be carried out at least annually or as determined by your fire risk assessment. If you have a high staff turnover, you may need to carry them out more often.

A well-planned and executed fire drill will confirm understanding of the training and provide helpful information for future training. The responsible person should determine the possible objectives of the drill such as to:

- identify any weaknesses in the evacuation strategy;
- test the procedure following any recent alteration or changes to working practices;
- familiarise new members of staff with procedures; and
- test the arrangements for disabled people and young persons on work experience.

### **Who should take part?**

Within each building the evacuation should include all occupants except those who may need to ensure the security of the premises, or people who, on a risk-assessed basis, are required to remain with particular equipment or processes that cannot be closed down.

Premises that consist of several buildings on the same site should be dealt with one building at a time over an appropriate period unless the emergency procedure dictates otherwise.

Where appropriate, you may find it helpful to include members of the public in your fire drill – ensuring that all necessary health and safety issues are addressed before you do so.

### **Carrying out the drill**

For premises that have more than one escape route, the escape plan should be designed to evacuate all people on the assumption that one exit or stairway is unavailable because of the fire. This could be simulated by a designated person being located at a suitable point on an exit route. Applying this scenario to different escape routes at each fire drill will encourage individuals to use alternative escape routes which they may not normally use.

When carrying out the drill you might find it helpful to:

- circulate details concerning the drill and inform all staff of their duty to participate. It may not be beneficial to have ‘surprise drills’ as the health and safety risks introduced may outweigh the benefits;
- ensure that equipment can be safely left;
- nominate observers;

- inform the alarm receiving centre if the fire-warning system is monitored (if the fire and rescue service is normally called directly from your premises, ensure that this does not happen);
- inform visitors and members of the public if they are present; and
- ask a member of staff at random to set off the alarm by operating the nearest alarm call point using the test key. This will indicate the level of knowledge regarding the location of the nearest call point.

More detailed information on fire drills and test evacuations is given in BS5588-12.<sup>52</sup>

### **The roll call/checking the premises have been evacuated**

Carry out a roll call as soon as possible at the designated assembly point(s), and/or receive reports from wardens designated to 'sweep' the premises. You should note any people who are unaccounted for. In a real evacuation this information will need to be passed to the fire and rescue service on arrival.

Check that people have assembled at the evacuation point.

Once the roll call is complete or all reports have been received, allow people to return to the building. If the fire-warning system is monitored, inform the alarm receiving centre that the drill has now been completed and record the outcomes of the drill.

### **Monitoring and debrief**

Throughout the drill the responsible person and nominated observers should pay particular attention to:

- communication difficulties with regard to the roll call and establishing that everyone is accounted for;
- the use of the nearest available escape routes as opposed to common circulation routes;
- difficulties with the opening of final exit doors;
- difficulties experienced by people with disabilities;
- the roles of specified people, e.g. fire wardens;
- inappropriate actions, e.g. stopping to collect personal items, attempting to use lifts, etc.; and
- windows and doors not being closed as people leave.

On-the-spot debriefs are useful to discuss the fire drill, encouraging feedback from everybody. Later, reports from fire wardens and observations from people should be collated and reviewed. Any conclusions and remedial actions should be recorded and implemented.

## Section 8 Quality assurance of fire protection equipment and installation

Fire protection products and related services should be fit for their purpose and properly installed and maintained in accordance with the manufacturer's instructions or a relevant standard.

Third-party certification schemes for fire protection products and related services are an effective means of providing the fullest possible assurances, offering a level of quality, reliability and safety that non-certificated products may lack. This does not mean goods and services that are not third-party approved are less reliable, but there is no obvious way in which this can be demonstrated.

Third-party quality assurance can offer comfort, both as a means of satisfying you that the goods and services you have purchased are fit for purpose, and as a means of demonstrating that you have complied with the law.

However, to ensure the level of assurance offered by third party schemes, you should always check whether the company you employ sub-contracts work to others. If they do, you will want to check that the sub-contractors are subject to the same level of checks of quality and competence as the company you are employing.

Your local fire and rescue service, fire trade associations or your own trade association may be able to provide further details about third-party quality assurance schemes and the various organisations that administer them.



## Appendix A

# A1 Example fire safety maintenance checklist

A fire safety maintenance checklist can be used as a means of supporting your fire safety policy. This example list is not intended to be comprehensive and should not be used as a substitute for carrying out a fire risk assessment.

You can modify the example, where necessary, to fit your premises and may need to incorporate the recommendations of

manufacturers and installers of the fire safety equipment/systems that you may have installed in your premises.

Any ticks in the grey boxes should result in further investigation and appropriate action as necessary. In larger and more complex premises you may need to seek the assistance of a competent person to carry out some of the checks.

	Yes	No	N/A	Comments
<b>Daily checks (not normally recorded)</b>				
<b>Escape routes</b>				
Can all fire exits be opened immediately and easily?	<input type="checkbox"/>	<input type="checkbox"/>	<input type="checkbox"/>	
Are fire doors clear of obstructions?	<input type="checkbox"/>	<input type="checkbox"/>	<input type="checkbox"/>	
Are escape routes clear?	<input type="checkbox"/>	<input type="checkbox"/>	<input type="checkbox"/>	
<b>Fire warning systems</b>				
Is the indicator panel showing 'normal'?	<input type="checkbox"/>	<input type="checkbox"/>	<input type="checkbox"/>	
Are whistles, gongs or air horns in place?	<input type="checkbox"/>	<input type="checkbox"/>	<input type="checkbox"/>	
<b>Escape lighting</b>				
Are luminaires and exit signs in good condition and undamaged?	<input type="checkbox"/>	<input type="checkbox"/>	<input type="checkbox"/>	
Is emergency lighting and sign lighting working correctly?	<input type="checkbox"/>	<input type="checkbox"/>	<input type="checkbox"/>	
<b>Firefighting equipment</b>				
Are all fire extinguishers in place?	<input type="checkbox"/>	<input type="checkbox"/>	<input type="checkbox"/>	
Are fire extinguishers clearly visible?	<input type="checkbox"/>	<input type="checkbox"/>	<input type="checkbox"/>	
Are vehicles blocking fire hydrants or access to them?	<input type="checkbox"/>	<input type="checkbox"/>	<input type="checkbox"/>	
<b>Weekly checks</b>				
<b>Escape routes</b>				
Do all emergency fastening devices to fire exits (push bars and pads, etc.) work correctly?	<input type="checkbox"/>	<input type="checkbox"/>	<input type="checkbox"/>	
Are external routes clear and safe?	<input type="checkbox"/>	<input type="checkbox"/>	<input type="checkbox"/>	
<b>Fire warning systems</b>				
Does testing a manual call point send a signal to the indicator panel? (Disconnect the link to the receiving centre or tell them you are doing a test.)	<input type="checkbox"/>	<input type="checkbox"/>	<input type="checkbox"/>	
Did the alarm system work correctly when tested?	<input type="checkbox"/>	<input type="checkbox"/>	<input type="checkbox"/>	
Did staff and other people hear the fire alarm?	<input type="checkbox"/>	<input type="checkbox"/>	<input type="checkbox"/>	
Did any linked fire protection systems operate correctly? (e.g. magnetic door holder released, smoke curtains drop)	<input type="checkbox"/>	<input type="checkbox"/>	<input type="checkbox"/>	

	Yes	No	N/A	Comments
<b>Weekly checks continued</b>				
Do all visual alarms and/or vibrating alarms and pagers (as applicable) work?	<input type="checkbox"/>	<input type="checkbox"/>	<input type="checkbox"/>	
Do voice alarm systems work correctly? Was the message understood?	<input type="checkbox"/>	<input type="checkbox"/>	<input type="checkbox"/>	
<b>Escape lighting</b>				
Are charging indicators (if fitted) visible?	<input type="checkbox"/>	<input type="checkbox"/>	<input type="checkbox"/>	
<b>Firefighting equipment</b>				
Is all equipment in good condition?	<input type="checkbox"/>	<input type="checkbox"/>	<input type="checkbox"/>	
Additional items from manufacturer's recommendations.	<input type="checkbox"/>	<input type="checkbox"/>	<input type="checkbox"/>	
<b>Monthly checks</b>				
<b>Escape routes</b>				
Do all electronic release mechanisms on escape doors work correctly? Do they 'fail safe' in the open position?	<input type="checkbox"/>	<input type="checkbox"/>	<input type="checkbox"/>	
Do all automatic opening doors on escape routes 'fail safe' in the open position?	<input type="checkbox"/>	<input type="checkbox"/>	<input type="checkbox"/>	
Are fire door seals and self-closing devices in good condition?	<input type="checkbox"/>	<input type="checkbox"/>	<input type="checkbox"/>	
Do all roller shutters provided for fire compartmentation work correctly?	<input type="checkbox"/>	<input type="checkbox"/>	<input type="checkbox"/>	
Are external escape stairs safe?	<input type="checkbox"/>	<input type="checkbox"/>	<input type="checkbox"/>	
Do all internal self-closing fire doors work correctly?	<input type="checkbox"/>	<input type="checkbox"/>	<input type="checkbox"/>	
<b>Escape lighting</b>				
Do all luminaires and exit signs function correctly when tested?	<input type="checkbox"/>	<input type="checkbox"/>	<input type="checkbox"/>	
Have all emergency generators been tested? (Normally run for one hour.)	<input type="checkbox"/>	<input type="checkbox"/>	<input type="checkbox"/>	
<b>Firefighting equipment</b>				
Is the pressure in 'stored pressure' fire extinguishers correct?	<input type="checkbox"/>	<input type="checkbox"/>	<input type="checkbox"/>	
Additional items from manufacturer's recommendations.	<input type="checkbox"/>	<input type="checkbox"/>	<input type="checkbox"/>	
<b>Three-monthly checks</b>				
<b>General</b>				
Are any emergency water tanks/ponds at their normal capacity?	<input type="checkbox"/>	<input type="checkbox"/>	<input type="checkbox"/>	
Are vehicles blocking fire hydrants or access to them?	<input type="checkbox"/>	<input type="checkbox"/>	<input type="checkbox"/>	
Additional items from manufacturer's recommendations.	<input type="checkbox"/>	<input type="checkbox"/>	<input type="checkbox"/>	
<b>Six-monthly checks</b>				
<b>General</b>				
Has any firefighting or emergency evacuation lift been tested by a competent person?	<input type="checkbox"/>	<input type="checkbox"/>	<input type="checkbox"/>	
Has any sprinkler system been tested by a competent person?	<input type="checkbox"/>	<input type="checkbox"/>	<input type="checkbox"/>	
Have the release and closing mechanisms of any fire-resisting compartment doors and shutters been tested by a competent person?	<input type="checkbox"/>	<input type="checkbox"/>	<input type="checkbox"/>	
<b>Fire warning system</b>				
Has the system been checked by a competent person?	<input type="checkbox"/>	<input type="checkbox"/>	<input type="checkbox"/>	

	Yes	No	N/A	Comments
<b>Six-monthly checks</b> <i>continued</i>				
<b>Escape lighting</b>				
Do all luminaires operate on test for one third of their rated value?	<input type="checkbox"/>	<input type="checkbox"/>	<input type="checkbox"/>	
Additional items from manufacturer's recommendations.	<input type="checkbox"/>	<input type="checkbox"/>	<input type="checkbox"/>	
<b>Annual checks</b>				
<b>Escape routes</b>				
Do all self-closing fire doors fit correctly?	<input type="checkbox"/>	<input type="checkbox"/>	<input type="checkbox"/>	
Is escape route compartmentation in good repair?	<input type="checkbox"/>	<input type="checkbox"/>	<input type="checkbox"/>	
<b>Escape lighting</b>				
Do all luminaires operate on test for their full rated duration?	<input type="checkbox"/>	<input type="checkbox"/>	<input type="checkbox"/>	
Has the system been checked by a competent person?	<input type="checkbox"/>	<input type="checkbox"/>	<input type="checkbox"/>	
<b>Firefighting equipment</b>				
Has all firefighting equipment been checked by a competent person?	<input type="checkbox"/>	<input type="checkbox"/>	<input type="checkbox"/>	
<b>Miscellaneous</b>				
Has any dry/wet rising fire main been tested by a competent person?	<input type="checkbox"/>	<input type="checkbox"/>	<input type="checkbox"/>	
Has the smoke and heat ventilation system been tested by a competent person?	<input type="checkbox"/>	<input type="checkbox"/>	<input type="checkbox"/>	
Has external access for the fire service been checked for ongoing availability?	<input type="checkbox"/>	<input type="checkbox"/>	<input type="checkbox"/>	
Have any firefighters' switches been tested?	<input type="checkbox"/>	<input type="checkbox"/>	<input type="checkbox"/>	
Has the fire hydrant bypass flow valve control been tested by a competent person?	<input type="checkbox"/>	<input type="checkbox"/>	<input type="checkbox"/>	
Are any necessary fire engine direction signs in place?	<input type="checkbox"/>	<input type="checkbox"/>	<input type="checkbox"/>	

## A2 Example form for recording significant findings

Risk Assessment – Record of significant findings		
<b>Risk assessment for</b>		<b>Assessment undertaken by</b>
Company		Date
Address		Completed by
		Signature
<b>Sheet number</b>	<b>Floor/area</b>	<b>Use</b>
<b>Step 1 – Identify fire hazards</b>		
<b>Sources of ignition</b>	<b>Sources of fuel</b>	<b>Sources of oxygen</b>
<b>Step 2 – People at risk</b>		
<b>Step 3 – Evaluate, remove, reduce and protect from risk</b>		
<b>(3.1) Evaluate the risk of the fire occurring</b>		
<b>(3.2) Evaluate the risk to people from a fire starting in the premises</b>		
<b>(3.3) Remove and reduce the hazards that may cause a fire</b>		
<b>(3.4) Remove and reduce the risks to people from a fire</b>		
<b>Assessment review</b>		
<b>Assessment review date</b>	<b>Completed by</b>	<b>Signature</b>
<b>Review outcome (where substantial changes have occurred a new record sheet should be used)</b>		

**Notes:**

- (1) The risk assessment record significant findings should refer to other plans, records or other documents as necessary.
- (2) The information in this record should assist you to develop an emergency plan; coordinate measures with other 'responsible persons' in the building; and to inform and train staff and inform other relevant persons.

## Appendix B

# Technical information on fire-resisting separation, fire doors and door fastenings

### B1 Fire-resisting separation

#### General

The materials from which your premises are constructed may determine the speed with which a fire may spread, affecting the escape routes that people will use. A fire starting in a building constructed mainly from readily combustible material will spread faster than one where modern fire-resisting construction materials have been used. Where non-combustible materials are used and the internal partitions are made from fire-resisting materials, the fire will be contained for a longer period, allowing more time for the occupants to escape.

Because of the requirements of the Building Regulations you will probably already have some walls and floors that are fire-resisting and limitations on the surface finishes to certain walls and ceilings.

You will need to consider whether the standard of fire resistance and surface finishing in the escape routes is satisfactory, has been affected by wear and tear or alterations and whether any improvements are necessary.

The following paragraphs give basic information on how fire-resisting construction can provide up to 30 minutes protection to escape routes. This is the standard recommended for most situations. If you are still unsure of the level of fire resistance which is necessary after reading this information, you should consult a fire safety expert.

#### Fire-resisting construction

The fire resistance of a wall or floor is dependent on the quality of construction and materials used. Common examples of types of construction that provide 30-minute fire resistance to escape routes if constructed to the above standards are:

- internal framed construction wall, non-load bearing, consisting of 72mm x 37mm timber studs at 600mm centres and faced with 12.5mm of plasterboard with all joints taped and filled (see Figure 65);
- internal framed construction, non-load bearing, consisting of channel section steel studs at 600mm centres faced with 12.5mm of plasterboard with all joints taped and filled; and
- masonry cavity wall consisting of solid bricks of clay, brick earth, shale, concrete or calcium silicate, with a minimum thickness of 90mm on each leaf.

Figure 65: Fire-resisting construction

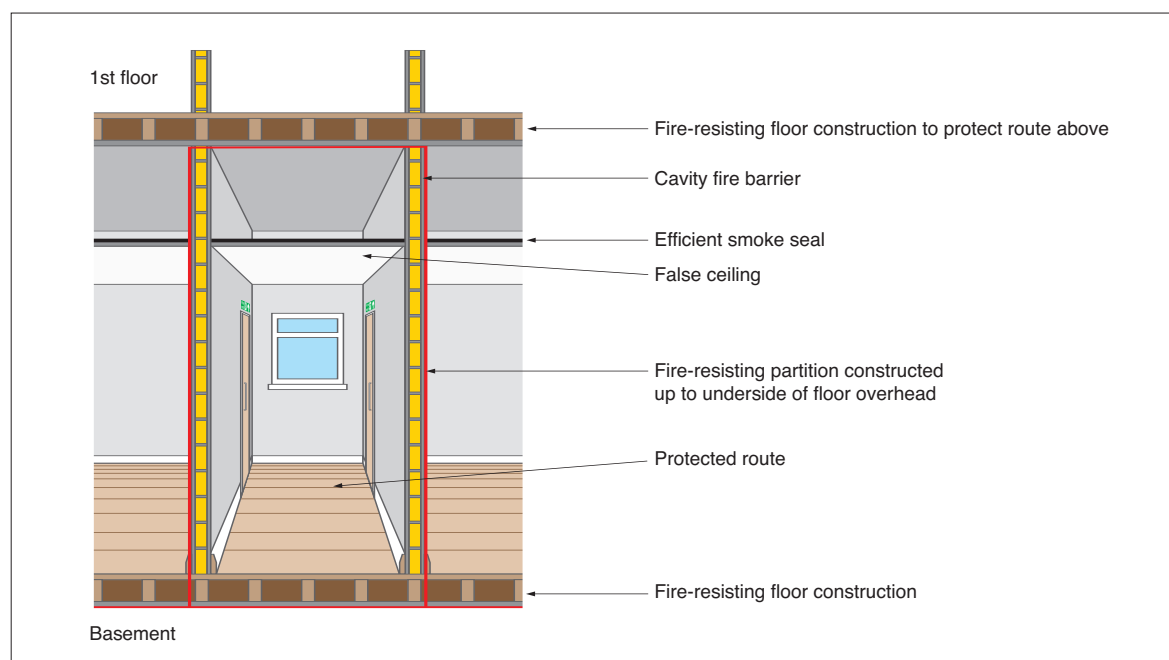

There are other methods and products available which will achieve the required standard of fire resistance and may be more appropriate for the existing construction in your premises. If there is any doubt about how your building is constructed, then ask for further advice from a competent person.

### **Fire-resisting floors**

The fire resistance of floors will depend on the existing floor construction as well as the type of ceiling finish beneath. If you need to upgrade the fire resistance of your floor it may not be desirable to apply additional fire resistance to the underside of an existing ornate ceiling. In older buildings there may be a requirement to provide fire resistance between beams and joists.

A typical example of a 30-minute fire-resisting timber floor is tongue and groove softwood of not less than 15mm finished thickness on 37mm timber joists, with a ceiling below of one layer of plasterboard to a thickness of 12.5mm with joints taped and filled and backed by supporting timber.

There are other, equally valid, methods and products available for upgrading floors. If you are in any doubt you should ask the advice of a competent person and ensure that the product is installed in accordance with instructions from the manufacturer or supplier.

### **Fire-resisting glazing**

The most common type of fire-resisting glazing is 6mm Georgian wired glazing, which is easily identifiable. Clear fire-resisting glazing is available and can quickly be identified by a mark etched into the glass, usually in the corner of the glazed panel, to confirm its fire-resisting standard. Although this is not compulsory, the marking of glass is supported by the Glass and Glazing Federation; you should check whether the glazing will be marked accordingly before purchase. The glazing should have been installed in accordance with the manufacturer's instructions and to the appropriate standard,<sup>66</sup> to ensure that its fire-resisting properties are maintained.

The performance of glazed systems in terms of fire resistance and external fire exposure should, wherever possible, be confirmed by test evidence. Alternatively, where there is a lack of test information, ask for an assessment of the proposed construction from suitably qualified people.

### **Fire separation of voids**

A common problem encountered with fire separation is fire-resisting partitions which do

not extend above false ceilings to true ceiling height. This may result in unseen fire spread and a loss of vital protection to the escape routes. It is important therefore to carefully check all such partitions have been installed correctly.

### **CLASP and SCOLA type construction**

CLASP (Consortium of Local Authorities Special Programme)\* and SCOLA (Second Consortium of Local Authorities) are total or systematic methods of construction that were developed to provide consistent building quality, while reducing the need for traditional skilled labour. They consist of a metal frame upon which structural panels are fixed. This results in hidden voids through which fire may spread. It is important that cavity barriers that restrict the spread of fire are installed appropriately, especially to walls and floors that need to be fire-resisting. If you are in any doubt as to whether any remedial work will be required, then ask for advice from a competent person.

### **Breaching fire separation**

To ensure effective protection against fire, walls and floors providing fire separation must form a complete barrier, with an equivalent level of fire resistance provided to any openings such as doors, ventilation ducts, pipe passages or refuse chutes.

The passing of services such as heating pipes or electrical cables through fire-resisting partitions leaves gaps through which fire and smoke may spread. This should be rectified by suitable fire stopping and there are many proprietary products available to suit particular types of construction. Such products should be installed by competent contractors.

### **Décor and surface finishes of walls, ceilings and escape routes**

The materials used to line walls and ceilings can contribute significantly to the spread of flame across their surface. Most materials that are used as surface linings will fall into one of three classes of surface spread of flame. The following are common examples of acceptable materials for various situations:

#### **Class 0: Materials suitable for circulation spaces and escape routes**

- Such materials include brickwork, blockwork, concrete, ceramic tiles, plaster finishes (including rendering on wood or metal lathes), wood-wool cement slabs and mineral fibre tiles or sheets with cement or resin binding.

\* [www.clasp.gov.uk](http://www.clasp.gov.uk)

**Note:** Additional finishes to these surfaces may be detrimental to the fire performance of the surface and if there is any doubt about this then consult the manufacturer of the finish.

### **Class 1: Materials suitable for use in all rooms but not on escape routes**

- Such materials include all the Class 0 materials referred to above. Additionally, timber, hardboard, blockboard, particle board, heavy flock wallpapers and thermosetting plastics will be suitable if flame-retardant treated to achieve a Class 1 standard.

### **Class 3: Materials suitable for use in rooms of less than 30m<sup>2</sup>**

- Such materials include all those referred to in Class 1, including those that have not been flame-retardant treated and certain dense timber or plywood and standard glass-reinforced polyesters.

The equivalent European classification standard will also be acceptable. Further details about internal linings and classifications are available in Approved Document B.<sup>24</sup> Appropriate testing procedures are detailed in BS 476-7<sup>33</sup> and where appropriate BS EN 13501-1.<sup>34</sup>

Further guidance on types of fire-resisting construction has been published by the Building Research Establishment.<sup>35</sup>

## **B2 Fire-resisting doors**

### **Requirements of a fire-resisting door**

Effective fire-resisting doors (see Figure 66) are vital to ensure that the occupants can evacuate to a place of safety. Correctly specified and well-fitted doors will hold back fire and smoke, preventing escape routes becoming unusable, as well as preventing the fire spreading from one area to another.

Fire-resisting doors are necessary in any doorway located in a fire-resisting structure. Most internal doors are constructed of timber. These will give some limited protection against fire spread, but only a purpose-built fire-resisting door that has been tested to an approved standard will provide the necessary protection. Metal fire-resisting doors are also available and specific guidance for these follows.

All fire-resisting doors are rated by their performance when tested to an appropriate standard. The level of protection provided by the door is measured, primarily by determining

the time taken for a fire to breach the integrity (E), of the door assembly, together with its resistance to the passage of hot gases and flame.

It may be possible to upgrade the fire resistance of existing doors. Further information is available from the Building Research Establishment<sup>67</sup> or the Timber Research and Development Association.<sup>68</sup>

Timber fire-resisting doors require a gap of 2-4mm between the door leaf and the frame. However larger gaps may be necessary to ensure that the door closes flush into its frame when smoke seals are fitted. Further information is available in BS 4787-1.<sup>69</sup> For fire-resisting purposes the gap is normally protected by installing an intumescent seal, in either the door or, preferably, the frame. The intumescent seal expands in the early stages of a fire and enhances the protection given by the door. Additional smoke seals will restrict the spread of smoke at ambient temperatures. Doors fitted with smoke seals, either incorporated in the intumescent seal or fitted separately, have their classification code suffixed with a 'S'.

The principal fire-resisting door categories are:

- E20 fire-resisting door providing 20 minutes fire resistance (or equivalent FD 20S). (Note: Many suppliers no longer provide an E20 type fire-resisting door.)
- E30 fire-resisting door providing 30 minutes fire resistance (or equivalent FD 30S).
- E60 fire-resisting door providing 60 minutes fire resistance (or equivalent FD 60S).

Timber fire-resisting doors are available that will provide up to 120 minutes fire resistance but their use is limited to more specialised conditions that are beyond the scope of this guidance.

### **Metal fire-resisting doors**

Although the majority of fire-resisting doors are made from timber, metal fire-resisting doors, which meet the appropriate standard, can often be used for the same purpose. However, there are situations, especially in large factories or warehouses, where they are more appropriate. The majority of metal fire-resisting door manufacturers will require the use of bespoke frames and hardware for their door sets.

See BS EN 1634-1<sup>36</sup> and BS 476-22<sup>37</sup> for more information.

For detailed guidance refer to Approved Document B.<sup>24</sup>

## Glazing in fire-resisting doors

Although glazing provides additional safety in everyday use and can enhance the appearance of fire-resisting doors, it should never reduce the fire resistance of the door. The opening provided in the door for the fire-resisting glazing unit(s) and the fitting of the beading are critical, and should only be entrusted to a competent person. In nearly all cases the door and glazing should be purchased from a reputable supplier who can provide documentary evidence that the door continues to achieve the required rating.

## Fire-resisting door furniture

### Hinges

To ensure compliance with their rated fire performance, fire-resisting doors need to be hung with the correct number, size and quality of hinges. Normally a minimum of three hinges are needed, however the manufacturer's instructions should be closely followed. BS EN 1935<sup>38</sup> including Annex B, is the appropriate standard.

### Alternative door mountings

Although the most common method of hanging a door is to use single axis hinges, alternative

methods are employed where the door is required to be double swing or mounted on pivots for other reasons.

Floor mounted controlled door closing devices are the most common method regularly found with timber, glass and steel doors while transom mounted devices are commonly used with aluminium sections. In each case reference should be made to the fire test report for details as to compliance with the composition of the door assembly including the door mounting conditions.

### Self-closing devices

All fire-resisting doors, other than those to locked cupboards and service ducts, should be fitted with an appropriately controlled self-closing device that will effectively close the door from any angle. In certain circumstances, concealed, jamb-mounted closing devices may be specified and in these cases should be capable of closing the door from any angle and against any latch fitted to the door; spring hinges are unlikely to be suitable. Further information is available in BS EN 1154.<sup>39</sup>

Rising butt hinges are not suitable for use as a self-closing device due to their inability to close and latch the door from any angle.

Figure 66: A fire-resisting and smoke-stopping door

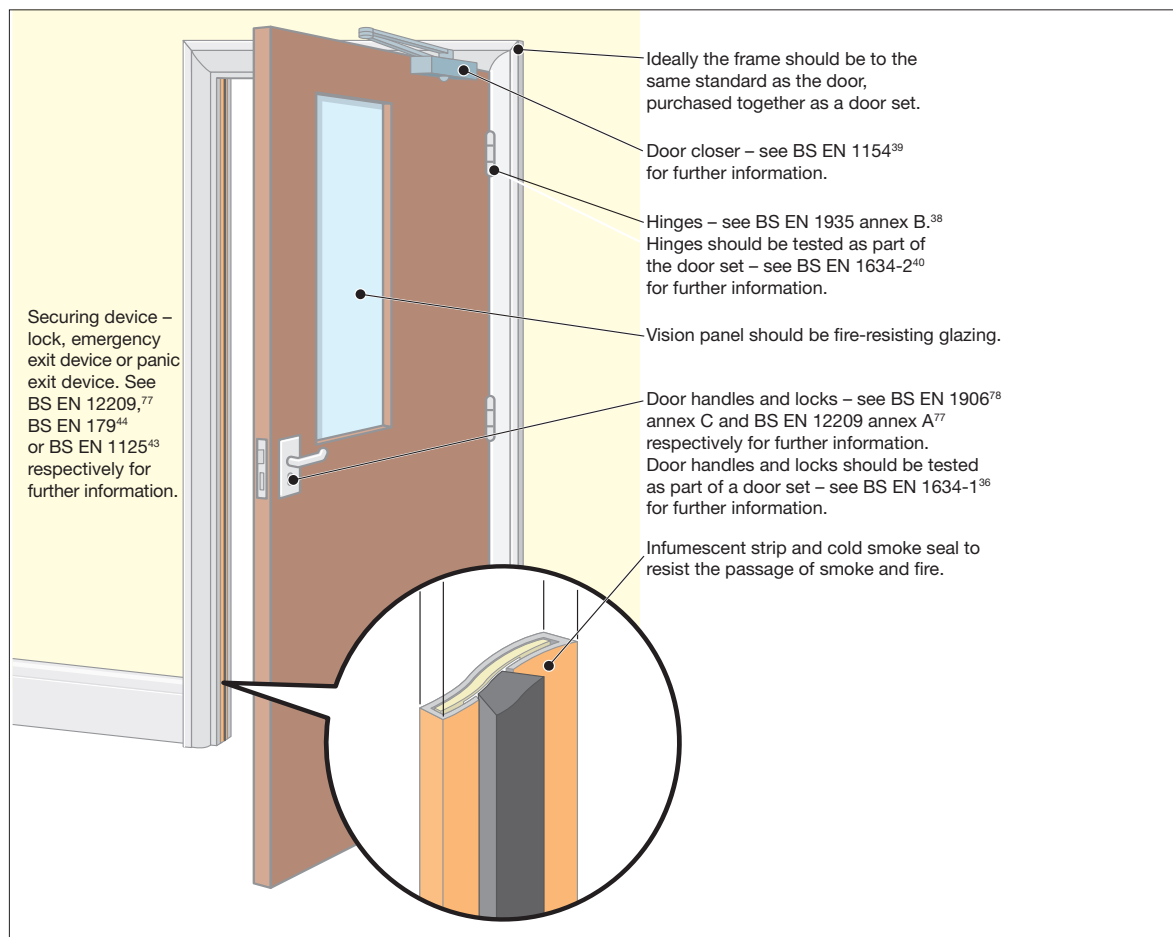



### Automatic door hold-open/release devices for self-closing fire doors

These devices are designed to hold open self-closing fire doors or allow them to swing free during normal use. In the event of a fire alarm the device will then release the door automatically, allowing the self-closing mechanism to close the door.

Such devices are particularly useful in situations where self-closing doors on escape routes are used regularly by significant numbers of people, or by people with impaired mobility who may have difficulty in opening the doors.

Typical examples of such devices include:

- electro-magnetic devices fitted to the fire-resisting door which release when the fire detection and warning system operates, allowing a separate self-closer to close the door;
- electro-magnetic devices within the controlled door closing device which function on the operation of the fire detection and warning system; and
- 'free swing' controlled door closing devices, which operate by allowing the door leaf to work independently of the closing device in normal conditions. An electro-magnetic device within the spring mechanism linked to the fire detection and warning system ensures that the door closes on the operation of the system.

**Note:** Free swing devices may not be suitable in some situations, such as corridors, where draughts are a problem and the doors are likely to swing uncontrolled, causing possible difficulty or injury to certain people e.g. those with certain disabilities, the elderly and frail, or young children.

Automatic door hold open/release devices fitted to doors protecting escape routes should only be installed in conjunction with an automatic fire detection and warning system incorporating smoke detectors, that is designed to protect the escape routes in the building (see Part 2, Section 2).

In all cases the automatic device should release the fire-resisting door allowing it to close effectively within its frame when any of the following conditions occur:

- the detection of smoke by an automatic detector;

- the actuation of the fire detection and alarm system by manual means e.g. operation of break glass call point;
- any failure of the fire detection and alarm system; or
- any electrical power failure.

Other devices, including self-contained devices which perform a similar function, that are not connected directly to a fire alarm system and are not therefore able to meet the above criteria are available and may be acceptable where a site-specific risk assessment can show that they are appropriate. Such devices are unlikely to be suitable for use on doors protecting single stairways or other critical means of escape.

In all cases where a door hold open device is used it should be possible to close the door manually.

A site specific risk assessment should be undertaken before any type of automatic door hold open/release device is installed. If you are unsure about the suitability of such devices in your premises, you should seek the advice of a competent person.

Further guidance about automatic door hold open/release devices is given in BS EN 1155<sup>70</sup> or BS 5839-3.<sup>40</sup>

### Door co-ordinators

Where pairs of doors with rebated meeting stiles are installed it is critical that the correct closing order is maintained. Door coordinators to BS EN 1158<sup>71</sup> should be fitted and fully operational in all cases where the doors are self-closing.

### Installation and workmanship

The reliability and performance of correctly specified fire-resisting doors can be undermined by inadequate installation. It is important that installers with the necessary level of skill and knowledge are used. Accreditation schemes for installers of fire-resisting doors are available.

Fire-resisting doors and shutters will require routine maintenance, particularly to power operation and release and closing mechanisms.

Further information is available on fire-resisting doors in BS 8214.<sup>42</sup> If you are unsure about the quality, the effectiveness or the fitting of your fire-resisting doors consult a fire safety expert.

For further guidance on the selection and maintenance of door furniture suitable for use on timber fire resisting and escape doors refer to the Building Hardware Industry Federation (BHIF) Code of Practice – Hardware for Timber Fire and Escape Doors.<sup>72</sup>

### B3 Door-fastening devices

The relationship between the securing of doors against unwanted entry and the ability to escape through them easily in an emergency has often proved problematical. Careful planning and the use of quality materials remain the most effective means of satisfying both of these objectives.

Any device that impedes people making good their escape, either by being unnecessarily complicated to manipulate or not being readily openable, will not be acceptable.

Guidance on fire exits starts from the position that doors on escape routes should not be fitted with any locking devices (electrically operated or otherwise). However, it is accepted that in many cases the need for security will require some form of device that prevents unlimited access, but still enables the occupants of a building or area to open the door easily if there is a fire. These devices can take many forms but, in the majority of cases, premises where there are members of the public present or others who are not familiar with the building should use panic exit bar devices (i.e. push bars or touch bars). See BS EN 1125<sup>43</sup> for further information.

Premises that have limited numbers of staff or others who are familiar with the building and where panic is not likely may use alternative devices (i.e. push pads or lever handles). See BS EN 179<sup>44</sup> for further information.

In some larger premises, when only certain staff are on the premises and there is a security issue, it may be acceptable to restrict the number of emergency exits immediately available, e.g. when only security staff are present at night in large premises, or prior to opening the premises to the public in the morning. Staff should be made fully aware of any restrictions and the number of exits not immediately available should be limited.

### Electrical locking devices

Electrically operated entry control devices have been developed for use as locking devices on fire exits. They fall into two main categories, electromechanical and electromagnetic.

- Electromechanical devices

Electromechanical devices comprise electromechanical lock keeps and draw bolts, which can be controlled by people inside the premises by entering a code or by using 'smart cards', which have been adapted to control the exit from certain areas. These devices have been fitted in many premises and may be linked to the fire-detection and/or warning system. Experience has shown that these devices can fail to open in a number of ways. They are dependent on a spring mechanism to return the lock keep or draw bolt(s) and are liable to jam when pressure is applied to the door. It is also relatively easy to fit them incorrectly. Electromechanical locking devices are normally unacceptable on escape doors, unless they are fitted with a manual means of overriding the locking mechanism, such as a push bar, push pad or lever handle or they do not rely on a spring mechanism, fail-safe open and are not affected by pressure, in which case the criteria for electromagnetic devices should be applied.

- Electromagnetic devices

These devices comprise a magnet and a simple fixed retaining plate with no moving parts and are therefore generally considered to be more reliable due to their inherent 'fail-safe unlocked' operation. Electromagnetic locking devices go some way to addressing the particular concerns surrounding electromechanical locking systems. The release of this type of device is controlled by the interruption of electrical current to an electromagnet either manually via a switch or other means, break-glass point (typically coloured green), or by linking to the fire-warning and/or detection system of the premises.

**Time-delay devices on escape routes**

A further development is the fitting of a time-delay system to the electronic door-locking device. This delays the actual opening of an exit door for a variable period following operation of the panic bar or other exit device. Periods of between five and 60 seconds can be pre-set at the manufacturing stage or can be adjusted when fitted. These are not usually acceptable for use by members of the public. However, they may be acceptable for use by staff who are familiar with their operation and are suitably trained in their use.

**Management of electronic door-control devices including time delays**

The use of such devices may be accepted by enforcing authorities if the responsible person can demonstrate, through a suitable risk assessment for each individual door, both the need and the adequate management controls to ensure that people can escape safely from the premises. In particular:

- Access control should not be confused with exit control. Many devices are available which control the access to the premises but retain the immediate escape facility from the premises.
- In public areas, when push bars are operated on escape doors, they should release the electromagnetic locks immediately and allow the exit doors to open.
- The requirement for exit control should be carefully assessed and should not be seen as a substitute for good management of the employees and occupants.
- All other alternatives should have been explored/evaluated prior to using these devices to ensure they do not affect the safety of occupants.
- The device should be connected to the fire warning and/or detection system.
- The device should incorporate a bypass circuit for immediate release on activation of the fire warning and/or detection system.
- Each door should be fitted with a single securing device.
- The emergency exit doors should be clearly labelled about how to operate them.
- Adequate control measures should be put in place to ensure the safety of the occupants.

The use of electronic door-locking devices should be considered with particular care in premises with a number of different occupancies. The management of a complicated system of evacuation for many different groups is unlikely to be practicable.

The technical standards in respect of sourcing, maintaining and testing must be extremely high.

When part of the management control system involves trained personnel helping others at these doors, it is vital to ensure these people are available.

The use of exit control devices should not be considered where the number of trained staff is low or where members of the public would be expected to operate the device without help.

In premises where there may be large numbers of people, the devices should only be considered when linked to a comprehensive automatic fire-detection and warning system in accordance with BS 5839-1.<sup>16</sup> There should be an additional means of manually overriding the locking device at each such exit (typically a green break-glass point).

The use of time-delay systems that prevent the opening of emergency exits for a pre-set time are primarily used to improve security. These add a further layer of complexity to the fire strategy and should not be considered in public areas. They should only be used in non-public areas when all other options such as relocating valuable stock or exterior boundary management have been addressed. Their value in preventing theft is likely to be transient as the use of the manual override becomes more widely known.

British Standard 8220-3<sup>45</sup> gives further advice on security in buildings and while this standard does refer to electronic locking devices, it also acknowledges that the balance must remain on the side of emergency escape rather than security.

## Appendix C

# Historic buildings

### General considerations

This appendix offers additional information about listed and historical buildings.

Fire risk assessments conducted for a factory or warehouse which is within a listed or historic building will need to endeavour to strike a balance between ensuring sufficient fire safety measures are in place for the safety of people, yet avoid extensive alterations and helping to maintain the character of the building.

As well as the fire risk assessment it is recommended that a general fire policy statement and manual is compiled. A person must be nominated to take responsibility for all aspects of fire safety. Usually the person charged with the management and control of the premises will be the 'responsible person' under the Order.<sup>1</sup>

The advice and/or consent of a building control body or any other relevant bodies (e.g. English Heritage) should form part of any fire risk assessment that impacts on the character of the building (e.g. replacement of doors, fittings, wooden panelling and decor) or material changes to existing escape routes. An ideal solution is one that is reversible, enabling the historic elements to be reinstated.

A fire safety adviser will be able to suggest alternatives to conventional fire precautions, such as:

- a fire engineering solution;
- upgrading existing doors and partitions in a sympathetic manner to improve their fire resistance; and
- considering the installation of specialist fire-detection or suppression systems.

Should the design and nature of the historic building preclude the introduction of conventional fire safety features, it will be necessary to manage the building in such a way that:

- limits the number of occupants, either staff or members of the public, inside the building;
- limits activities in the building; and
- provides adequate supervision within the building.

### Liaison with the fire and rescue service

The responsible person will need to ensure effective liaison with the fire and rescue service to enable them to carry out firefighting operations. These may include information on:

- the provision of water supplies, seasonal ponds, lakes and underground tanks, and any associated pumps;
- difficult access for fire engines;
- particular hazards in the construction features of the building (including asbestos);
- the use of combustibles under floor insulation;
- underground vaults ducts and voids where fire may spread unchecked;
- worn stone slabs in stairway construction; and
- the presence of cast iron columns and wrought iron beams.

### Emergency planning

An important consideration for the owners and trustees is the protection of valuable artefacts and paintings from the effects of fire. However, the efficient evacuation of all occupants must take precedence over procedures for limiting damage to property and contents. Salvage work should be limited to those parts of the building not directly affected by the fire.

Fire wardens and others tasked with carrying out salvage work should have received formal training, adequate protection and be fully briefed about the health and safety risk assessment carried out to identify the dangers associated with this activity. Further detailed advice on fire safety in historic buildings can be found in the following publications:

- BS 7913: Guide to the principles of the conservation of historic buildings, British Standards Institution
- Heritage under fire: A guide to the protection of historic buildings, Fire Protection Association (for the UK Working Party on Fire Safety in Historic Buildings) 1991, ISBN 0 902167 94 4
- The Installation of Sprinkler Systems in Historic Buildings (Historic Scotland Technical Advice Note S), Fire Protection Association (TCRE Division/Scottish Conservation Bureau, Hist.) 1998, ISBN 1 900168 63 4
- Fire Protection Measures in Scottish Historic Buildings: Advice on Measures Required to Minimise the Likelihood of Fire Starting and to Alleviate the Destructive Consequences of Fire in Historic Buildings (Technical Advice Note), TCRE Division/Scottish Conservation Bureau, Hist. 1997, ISBN 1 900168 41 3
- Fire Risk Management in Heritage Buildings (Technical Advice Note), TCRE Division/Scottish Conservation Bureau, Hist. 2001, ISBN 1 900168 71 5
- Summary and conclusions of the report into fire protection measures for the Royal Palaces by Sir Alan Bailey following the Windsor Castle fire, 1992.
- The fire at Upton Park. The National Trust.
- Timber panelled doors and fire, English Heritage.
- Fire safety in historic town centres, English Heritage and Cheshire Fire and Rescue Service.

## Appendix D

# Glossary

These definitions are provided to assist the responsible person in understanding some of the technical terms used in this guide. They are not exhaustive and more precise definitions may be available in other guidance.

Term	Definition
Access room	A room through which the only escape route from an inner room passes.
Accommodation stairway	A stairway, additional to that required for means of escape purposes provided for the convenience of occupants.
Alterations notice	If your premises are considered by the enforcing authority to be high risk, they may issue an alterations notice that requires you to inform them before making any material alterations to your premises.
Alternative escape route	Escape routes sufficiently separated by either direction and space, or by fire-resisting construction to ensure that one is still available irrespective of the location of a fire.
Approved Document B (ADB) <sup>24</sup>	Guidance issued by Government in support of the fire safety aspects of the building regulations.
As low as reasonably practicable	Is a concept where risks should continue to be reduced until you reach a point where the cost and effort to reduce the risk further would be grossly disproportionate to the benefit achieved.
Automatic fire detection system	A means of automatically detecting the products of a fire and sending a signal to a fire warning system. See 'Fire warning'.
Basement	A storey with a floor which at some point is more than 1,200mm below the highest level of ground adjacent to the outside walls, unless, and for escape purposes only, such area has adequate, independent and separate means of escape.
Child	Anyone who is not over compulsory school age, i.e. before or just after their 16th birthday.
Class 0, 1 or 3 surface spread of flame	Classes of surface spread of flame for materials needed to line the walls and ceilings of escape routes. See Appendix B for further information.
Combustible material	A substance that can be burned.
Compartment wall and/or floor	A fire-resisting wall or floor that separates one fire compartment from another.
Competent person	A person with enough training and experience or knowledge and other qualities to enable them properly to assist in undertaking the preventive and protective measures.

Term	Definition
Dangerous substance	<p>1. A substance which because of its physico-chemical or chemical properties and the way it is used or is present at the workplace creates a risk.</p> <p>2. A substance subject to the Dangerous Substances and Explosive Atmosphere Regulations 2002 (DSEAR).</p>
Dead end	Area from which escape is possible in one direction only.
Direct distance	The shortest distance from any point within the floor area to the nearest storey exit, or fire-resisting route, ignoring walls, partitions and fixings.
Domestic premises	Premises occupied as a private dwelling, excluding those areas used in common by the occupants of more than one such dwelling.
Emergency escape lighting	Lighting provided to illuminate escape routes that will function if the normal lighting fails.
Enforcing authority	The fire and rescue authority or any other authority specified in Article 25 of the Regulatory Reform (Fire Safety) Order 2005. <sup>1</sup>
Escape route	Route forming that part of the means of escape from any point in the premises to a final exit.
Evacuation lift	A lift that may be used for the evacuation of people with disabilities, or others, in a fire.
External escape stair	Stair providing an escape route, external to the building.
Fail-safe	Locking an output device with the application of power and having the device unlock when the power is removed. Also known as fail unlock, reverse action or power locked.
False alarm	A fire signal, usually from a fire warning system, resulting from a cause other than fire.
Final exit	An exit from a building where people can continue to disperse in safety and where they are no longer at danger from fire and/or smoke.
Fire compartment	A building, or part of a building, constructed to prevent the spread of fire to or from another part of the same building or an adjoining building.
Fire door	A door or shutter, together with its frame and furniture, provided for the passage of people, air or goods which, when closed is intended to restrict the passage of fire and/or smoke to a predictable level of performance.
Firefighting lift	A lift, designed to have additional protection, with controls that enable it to be used under the direct control of the fire and rescue service when fighting a fire.
Firefighting shaft	A fire-resisting enclosure containing a firefighting stair, fire mains, firefighting lobbies and if provided, a firefighting lift.

Term	Definition
Firefighting stairway	See firefighting shaft.
Fire resistance	The ability of a component or construction of a building to satisfy, for a stated period of time, some or all of the appropriate criteria of relevant standards. (Generally described as 30 minutes fire-resisting or 60 minutes fire-resisting.) See BS EN 1363-1, <sup>46</sup> BS 476-7 <sup>33</sup> and associated standards for further information.
Fire safety manager	A nominated person with responsibility for carrying out day-to-day management of fire safety. (This may or may not be the same as the 'responsible person'.)
Fire safety strategy	A number of planned and co-ordinated arrangements designed to reduce the risk of fire and to ensure the safety of people if there is a fire.
Fire stopping	A seal provided to close an imperfection of fit or design tolerance between elements or components, to restrict the passage of fire and smoke.
Fire-warning system	A means of alerting people to the existence of a fire. (See automatic fire detection system.)
Flammable material	Easily ignited and capable of burning rapidly.
Highly flammable	Generally liquids with a flashpoint of below 21°C.  (The Chemicals Hazard Information and Packaging for Supply Regulations 2002 <sup>47</sup> (CHIP) give more detailed guidance.)
Hazardous substance	1. See Dangerous substance.  2. A substance subject to the Control of Substances Hazardous to Health Regulations 2002 (COSHH).
Inner room	A room from which escape is possible only by passing through another room (the access room).
Licensed premises	Any premises that require a licence under any statute to undertake trade or conduct business activities.
Material change	An alteration to the premises, process or service which significantly affects the level of risk to people from fire in those premises.
Means of escape	Route(s) provided to ensure safe egress from the premises or other locations to a place of total safety.
Phased evacuation	A system of evacuation in which different parts of the premises are evacuated in a controlled sequence of phases, those parts of the premises expected to be at greatest risk being evacuated first.
Place of reasonable safety	A place within a building or structure where, for a limited period of time, people will have some protection from the effects of fire and smoke. This place, usually a corridor or stairway, will normally have a minimum of 30 minutes fire resistance and allow people to continue their escape to a place of total safety.



Term	Definition
Place of total safety	A place, away from the premises, in which people are at no immediate danger from the effects of a fire.
Premises	Any place, such as a building and the immediate land bounded by any enclosure of it, any tent, moveable or temporary structure or any installation or workplace.
Protected lobby	A fire-resisting enclosure providing access to an escape stairway via two sets of fire doors and into which no room opens other than toilets and lifts.
Protected stairway	A stairway which is adequately protected from the rest of the building by fire-resisting construction.
Protected route	An escape route which is adequately protected from the rest of the building by fire-resisting construction.
Refuge	A place of reasonable safety in which a disabled person and others who may need assistance may rest or wait for assistance before reaching a place of total safety. It should lead directly to a fire-resisting escape route.
Responsible person	The person ultimately responsible for fire safety as defined in the Regulatory Reform (Fire Safety) Order 2005. <sup>1</sup>
Relevant persons	Any person lawfully on the premises and any person in the immediate vicinity, but does not include firefighters carrying out firefighting duties.
Self-closing device	A device that is capable of closing the door from any angle and against any latch fitted to the door.
Significant finding	<p>A feature of the premises, from which the fire hazards and persons at risk are identified.</p> <p>The actions you have taken or will take to remove or reduce the chance of a fire occurring or the spread of fire and smoke.</p> <p>The actions people need to take in case of fire.</p> <p>The necessary information, instruction and training needed and how it will be given.</p>
Smoke alarm	Device containing within one housing all the components, except possibly the energy source, for detecting smoke and giving an audible alarm.
Staged fire alarms	A fire warning which can be given in two or more stages for different purposes within a given area (i.e. notifying staff, stand by to evacuate, full evacuation).
Storey exit	A final exit or a doorway giving direct access into a protected stairway, firefighting lobby, or external escape route.
Travel distance	The actual distance to be travelled by a person from any point within the floor area to the nearest storey exit or final exit, having regard to the layout of walls, partitions and fixings.

Term	Definition
Vision panel	A transparent panel in a wall or door of an inner room enabling the occupant to become aware of a fire in the access area during the early stages.
Way guidance	Low mounted luminous tracks positioned on escape routes in combination with exit indicators, exit marking and intermediate direction indicators along the route, provided for use when the supply to the normal lighting fails, which do not rely on an electrical supply for their luminous output.
Where necessary	<p>The Order requires that fire precautions (such as firefighting equipment, fire detection and warning, and emergency routes and exits) should be provided (and maintained) 'where necessary'.</p> <p>What this means is that the fire precautions you must provide (and maintain) are those which are needed to reasonably protect relevant persons from risks to them in case of fire. This will be determined by the findings of your risk assessment including the preventative measures you have or will have taken. In practice, it is very unlikely, that a properly conducted fire risk assessment, which takes into account all the matters relevant for the safety of persons in case of fire, will conclude that no fire precautions (including maintenance) are necessary.</p>
Young person	<p>(a) A person aged 16 years, from the date on which he attains that age until and including the 31st August which next follows that date.</p> <p>(b) A person aged 16 years and over who is undertaking a course of full-time education at a school or college which is not advanced education.</p> <p>(c) A person aged 16 years and over who is undertaking approved training that is not provided through a contract of employment.</p> <p>For the purposes of paragraphs (b) and (c) the person:</p> <p>(a) shall have commenced the course of full-time education or approved training before attaining the age of 19 years; and</p> <p>(b) shall not have attained the age of 20 years.</p>

## References

The following documents are referenced in this guide. Where dated, only this version applies. Where undated, the latest version of the document applies.

- 1 Regulatory Reform (Fire Safety) Order 2005, SI 2005/1541. The Stationery Office, 2005. ISBN 0 11 072945 5.
- 2 Fire Precautions Act 1971 (c 40). The Stationery Office, 1971. ISBN 0 10 544071 X.
- 3 Fire Precautions (Workplace) Regulations 1997, SI 1997/1840. The Stationery Office, 1997. ISBN 0 11 064738 6.
- 4 Fire Precautions (Workplace) (Amendment) Regulations 1999, SI 1999/1877. The Stationery Office, 1999. ISBN 0 11 082882 8.
- 5 Health and Safety (Safety Signs and Signals) Regulations 1996, SI 1996/341. The Stationery Office, 1996. ISBN 0 11 054093 X.
- 6 *Safety signs and signals. The Health and Safety (Safety Signs and Signals) Regulations 1996. Guidance on regulations*, L64. HSE Books, 1996. ISBN 0 7176 0870 0.
- 7 Dangerous Substances and Explosive Atmospheres Regulations 2002, SI 2002/2776. The Stationery Office, 2002. ISBN 0 11 042957 5.
- 8 *Dangerous substances and explosive atmospheres. Dangerous Substances and Explosive Atmospheres Regulations 2002. Approved code of practice and guidance*, L138. HSE Books, 2003. ISBN 0 7176 2203 7.
- 9 *Storage of full and empty LPG cylinders and cartridges. Code of Practice 7*. LP Gas Association, 2000. Available from LP Gas Association, Pavilion 16, Headlands Business Park, Salisbury Road, Ringwood, Hampshire BH24 3PB.
- 10 *Maintaining portable electrical equipment in offices and other low-risk environments*, INDG236. HSE Books, 1996. (ISBN 0 7176 1272 4 single copy free or priced packs of 10).
- 11 Construction (Health, Safety and Welfare) Regulations 1996, SI 1996/1592. The Stationery Office, 1996. ISBN 0 11 035904 6.
- 12 *A guide to the Construction (Health, Safety and Welfare) Regulations 1996*, INDG220. HSE Books, 1996. (ISBN 0 7176 1161 2 single copy free or priced packs of 10).  
*Health and safety in construction*, HSG150 (second edition). HSE Books, 2001. ISBN 0 7176 2106 5.
- 13 Disability Discrimination Act 1995 (c 50). The Stationery Office, 1995. ISBN 0 10 545095 2.
- 14 BS 8300: *The design of buildings and their approaches to meet the needs of disabled people. Code of practice*. British Standards Institution. ISBN 0 580 38438 1.
- 15 ODPM/CACFOA/BFPSA guidance on reducing false alarms.
- 16 BS 5839-1: *Fire detection and alarm systems for buildings. Code of practice for system design, installation, commissioning and maintenance*. British Standards Institution. ISBN 0 580 40376 9.
- 17 Manual Handling Operations Regulations 1992, SI 1992/2793. The Stationery Office, 1992. ISBN 0 11 025920 3.
- 18 BS 5306-8: *Fire extinguishing installations and equipment on premises. Selection and installation of portable fire extinguishers. Code of practice*. British Standards Institution. ISBN 0 580 33203 9.
- 19 BS 5306-3: *Fire extinguishing installations and equipment on premises. Code of practice for the inspection and maintenance of portable fire extinguishers*. British Standards Institution. ISBN 0 580 42865 6.
- 20 BS 7863: *Recommendations for colour coding to indicate the extinguishing media contained in portable fire extinguishers*. British Standards Institution. ISBN 0 580 25845 9.
- 21 BS EN 671-3: *Fixed firefighting systems. Hose systems. Maintenance of hose reels with semi-rigid hose and hose systems with lay-flat hose*. British Standards Institution. ISBN 0 580 34112 7.
- 22 BS EN 12845: *Fixed firefighting systems. Automatic sprinkler systems. Design, installation and maintenance*. British Standards Institution. ISBN 0 580 44770 7.

- 23 Workplace (Health, Safety and Welfare) Regulations 1992, SI 1992/3004. The Stationery Office, 1992. ISBN 0 11 025804 5.
- 24 *The Building Regulations 2000 (as amended 2001): Approved document B Fire Safety*. The Stationery Office. ISBN 0 11 753911-2.
- 25 Local Government (Miscellaneous Provisions) Act 1982 (c 30). The Stationery Office, 1982. ISBN 0 10 543082 X.
- 26 BS 5395-2: *Stairs, ladders and walkways. Code of practice for the design of industrial type stairs, permanent ladders and walkways*. British Standards Institution. ISBN 0 580 14706 1.
- 27 BS 5266-8: *Emergency lighting. Code of practice for emergency escape lighting systems*. British Standards Institution.
- 28 BS 5266-1: *Emergency lighting. Code of practice for the emergency lighting of premises other than cinemas and certain other specified premises used for entertainment*. British Standards Institution.
- 29 BS EN 1838: *Lighting applications. Emergency lighting*. British Standards Institution. ISBN 0 580 32992 5.
- 30 BS 5499-4: *Safety signs, including fire safety signs. Code of practice for escape route signing*. British Standards Institution.
- 31 BS 7974: *Application of fire safety engineering principles to the design of buildings. Code of practice* British Standards Institution. ISBN 0 580 38447 0.
- 32 *Successful health and safety management*, HSG65 (second edition). HSE Books, 1997. ISBN 0 7176 1276 7.
- 33 BS 476-7: *Fire tests on building materials and structures. Method of test to determine the classification of the surface spread of flame of products*. British Standards Institution.
- 34 BS EN 13501-1: *Fire classification of construction products and building elements. Classification using test data from reaction to fire tests*. British Standards Institution.
- 35 *Guidelines for the construction of fire resisting structural elements*, BR 128 Building Research Establishment, 1988.
- 36 BS EN 1634-1: *Fire resistance tests for door and shutter assemblies Fire doors and shutters*. British Standards Institution. ISBN 0 580 32429 X.
- 37 BS 476-22: *Fire tests on building materials and structures. Methods for determination of the fire resistance of non-loadbearing elements of construction*. British Standards Institution. ISBN 0 580 15872 1.
- 38 BS EN 1935: *Building hardware. Single-axis hinges. Requirements and test methods*. British Standards Institution. ISBN 0 580 39272 4.
- 39 BS EN 1154: *Building hardware. Controlled door closing devices. Requirements and test methods*. British Standards Institution. ISBN 0 580 27476 4.
- 40 BS EN 1634-2: *Fire resistance tests for door and shutter assemblies. Part 2. Fire door hardware. Building hardware for fire resisting doorsets and openable windows*. British Standards Institution.
- 41 BS 5839-3: *Fire detection and alarm systems for buildings. Specification for automatic release mechanisms for certain fire protection equipment*. British Standards Institution. ISBN 0 580 15787 3.
- 42 BS 8214: *Code of practice for fire door assemblies with non-metallic leaves*. British Standards Institution. ISBN 0 580 18871 6.
- 43 BS EN 1125: *Building hardware. Panic exit devices operated by a horizontal bar. Requirements and test methods*. British Standards Institution.
- 44 BS EN 179: *Building hardware. Emergency exit devices operated by a lever handle or push pad. Requirements and test methods*. British Standards Institution. ISBN 0 580 28863 3.
- 45 BS 8220: *Guide for security of buildings against crime. Offices and shops*. British Standards Institution. ISBN 0 580 23692 7.
- 46 BS EN 1363-1: *Fire resistance tests. General requirements*. British Standards Institution.
- 47 Chemicals (Hazard Information and Packaging for Supply) Regulations 2002, SI 2002/1689. The Stationery Office, 2002. ISBN 0 11 042419 0.
- 48 *Guide to the safe warehousing of aerosols*. British Aerosol Manufacturers Association.
- 49 *The storage of flammable liquids in containers*, HSG 51. Health and Safety Executive.

- 50 *Manufacture and storage of explosives. Manufacture and Storage of Explosives Regulations 2005. Approved code of practice and guidance*, L139. HSE Books, 2005. ISBN 0 7176 2816 7.
- 51 *Storing and selling fireworks safely*, INDG407. Health and Safety Executive.
- 52 BS 5588-12: *Fire precautions in the design, construction and use of buildings – Part 12: Managing fire safety*. British Standards Institution.
- 53 The Electricity at Work Regulations 1989. SI 1989/635.
- 54 The Electrical Equipment (Safety) Regulations 1994, SI 1994/3260.
- 55 The Construction (Design and Management) Regulations 1994 (CONDAM/CDM Regs). HMSO, 1994.
- 56 *Construction Information Sheet No. 51: Construction fire safety*. Health and Safety Executive.
- 57 *Fire safety in construction work*, HSG 168. Health and Safety Executive. ISBN 0 7176 1332 1.
- 58 *Fire prevention on construction sites: The joint code of practice on the protection from fire of construction sites and buildings undergoing renovation* (fifth edition). Fire Protection Association and Construction Federation, 2000. ISBN 0 902167 39 1).
- 59 *Design, construction, specification and fire management of insulated envelopes for temperature controlled environments*. International Association for Cold Storage Construction.
- 60 BS 5306-2: *Fire extinguishing installations and equipment on premises. Specification for sprinkler systems*. British Standards Institution.
- 61 BS 5588-5: *Fire precautions in the design, construction and use of buildings. Access and facilities for firefighting*. British Standards Institution.
- 62 *The Building Regulations 1991: Approved Document M access to and use of buildings* (2004 edition). The Stationery Office
- 63 BS 5588-8: *Fire precautions in the design, construction and use of buildings. Code of practice for means of escape for disabled people*. British Standards Institution.
- 64 *CIBSE Guide Volume E: Fire engineering*. Chartered Institution of Building Services Engineers, 1997.
- 65 *Design methodologies for smoke and heat exhaust ventilation*, Report 368. BRE, 1999.
- 66 *A guide to best practice in the specification and use of fire-resistant glazed systems*. Glass and Glazing Federation, 2005.
- 67 *Increasing the fire resistance of existing timber doors*, Information Paper 8/82. BRE.
- 68 *Fire resisting doorsets by upgrading*. Wood Information Sheet 1-32. Timber Research and Development Association.
- 69 BS 4787-1: *Internal and external wood doorsets, door leaves and frames. Specification for dimensional requirements*. British Standards Institution.
- 70 BS EN 1155: *Building hardware. Electrically powered hold-open devices for swing doors. Requirements and test methods*. British Standards Institution.
- 71 BS EN 1158: *Building hardware. Door coordinator devices. Requirements and test methods*. British Standards Institution.
- 72 *Hardware for timber fire and escape doors*. BHIF, 2000.
- 73 BS 5266-6: *Emergency lighting. Code of practice for non-electrical low mounted way guidance systems for emergency use. Photoluminescent systems*. British Standards Institution.
- 74 BS 5499-5: *Graphical symbols and signs. Safety signs, including fire safety signs. Signs with specific safety meanings*. British Standards Institution.
- 75 'Sprinklers: High piled and rack storage'. *Fire Surveyor*, Vol. 9, No. 1, 21–26, February 1990.
- 76 *Safe handling of combustible dusts: Precautions against explosions*. HSG103 (second edition). HSE Books, 2003. ISBN 0 7176 2726 8.
- 77 BS EN 12209: *Building hardware. Locks and latches. Mechanically operated locks, latches and locking plate*. British Standards Institution.
- 78 BS EN 3-7: *Portable fire extinguishers. Characteristics, performance requirements and test methods*. British Standards Institution.

## Further reading

The latest versions of all documents listed in this section should be used, including any amendments.

Any views expressed in these documents are not necessarily those of the DCLG.

BS 4422	Fire. Vocabulary. British Standards Institution.
BS PD 6512-3	Use of elements of structural fire protection with particular reference to the recommendations given in BS 5588 <i>Fire precautions in the design and construction of buildings. Guide to the fire performance of glass</i> . British Standards Institution.
BS 5588-11	Fire precautions in the design, construction and use of buildings. Code of practice for shops, offices, industrial, storage and other similar buildings. British Standards Institution.
BS EN 81	Safety rules for the construction and installation of lifts. British Standards Institution.
BS EN 81-70	Safety rules for the construction and installation of lifts. Particular applications for passenger and goods passenger lifts. Accessibility to lifts for persons including persons with disability. British Standards Institution.
BS 5839-6	Fire detection and alarm systems for buildings. Code of practice for the design, installation and maintenance of fire detection and fire alarm systems in dwellings. British Standards Institution.
BS 5041-1	Fire hydrant systems equipment. Specification for landing valves for wet risers. British Standards Institution.
BSd 5041-2	Fire hydrant systems equipment. Specification for landing valves for dry risers. British Standards Institution.
BS 5041-3	Fire hydrant systems equipment. Specification for inlet breechings for dry riser inlets. British Standards Institution.
BS 5041-4	Fire hydrant systems equipment. Specification for boxes for landing valves for dry risers. British Standards Institution.
BS 5041-5	Fire hydrant systems equipment. Specification for boxes for foam inlets and dry riser inlets. British Standards Institution.
BS 9990	Code of practice for non-automatic firefighting systems in buildings. British Standards Institution.
BS 7944	Type 1 heavy duty fire blankets and type 2 heavy duty heat protective blankets. British Standards Institution.
BS EN 1869	Fire blankets. British Standards Institution.
BS ISO 14520-1	Gaseous fire-extinguishing systems. Physical properties and system design. General requirements. British Standards Institution.

BS 5266-2	Emergency lighting. Code of practice for electrical low mounted way guidance systems for emergency use. British Standards Institution.
BS EN 60598-1	Luminaires. General requirements and tests. British Standards Institution.
BS 5499-1	Graphical symbols and signs. Safety signs, including fire safety signs. Specification for geometric shapes, colours and layout. British Standards Institution.
BS EN 1634-3	Fire resistance tests for door and shutter assemblies. Smoke control doors and shutters. British Standards Institution.
BS 8214	Code of practice for fire door assemblies with non-metallic leaves. British Standards Institution.
Draft BS EN 14637	Building hardware. Electrically controlled hold-open systems for fire/smoke door assemblies. Requirements, test methods, application and maintenance. (Consultation document.) British Standards Institution.
BS EN 45020	Standardisation and related activities. General vocabulary. British Standards Institution.
ISO 13784-2	Reaction to fire tests for sandwich panel building systems. Part 2: test method for large rooms. British Standards Institution.
BS 6661	Guide for design, construction and maintenance of single-skin air supported structures. British Standards Institution.
BS 5268-4.2	Structural use of timber. Fire resistance of timber structures. Recommendations for calculating fire resistance of timber stud walls and joisted floor constructions. British Standards Institution.
BS 7671	Requirements for electrical installations: IEE wiring regulations.

*Design principles of fire safety.* The Stationery Office, 1996. ISBN 0 11 753045 X.

Chemicals (Hazard Information and Packaging for Supply) Regulations 2002, SI 2002/1689. The Stationery Office, 2002. ISBN 0 11 042419 0. Supporting guides: *The idiot's guide to CHIP 3: Chemicals (Hazard Information and Packaging for Supply) Regulations 2002*, INDG350. HSE Books, 2002. (ISBN 0 7176 2333 5 single copy free or priced packs of 5); *CHIP for everyone*, HSG228. HSE Books, 2002. ISBN 0 7176 2370 X.

*Guidance on the acceptance of electronic locks to doors required for means of escape.* The Chief and Assistant Chief Fire Officers' Association.

*Ensuring best practice for passive fire protection in buildings.* Building Research Establishment, 2003. ISBN 1 870409 19 1.

*Smoke shafts protecting fire shafts: their performance and design*, BRE Project Report 79204. Building Research Establishment, 2002.

*Design, construction, specification and fire management of insulated envelopes for temperature controlled environments.* International Association for Cold Storage Construction, 1999.

*Fire safety of PTFE-based material used in building*, BRE Report 274. Building Research Establishment, 1994. ISBN 0 851256 53 8.

*Fires and human behaviour.* David Fulton Publishers, 2000. ISBN 1 85346 105 9.

*Management of health and safety at work. Management of Health and Safety at Work Regulations 1999. Approved code of practice and guidance*, L21 (second edition). HSE Books, 2000. ISBN 0 7176 2488 9.

*Fire safety in construction work*, HSG168, HSE Books, 1997. ISBN 0 7176 1332 1.

*Construction fire safety*, Construction Information Sheet No.51. HSE Books, 1997.

*Fire prevention on construction sites: The joint code of practice on the protection from fire of construction sites and buildings undergoing renovation* (fifth edition). Construction Confederation/Fire Protection Association, 2000. ISBN 0 902167 39 1.

*Safe use of handling of flammable liquids*, HSG140. HSE Books, 1996. ISBN 0 7176 0967 7.

*Chemical warehousing: The storage of packaged dangerous substances*, HSG71. HSE Books, 1998. ISBN 0 7176 1484 0.

*Guidance on the assessment of fire risk: A practical approach*. The Cold Storage and Distribution Federation, 2000.

*The RFIC guide to the management and control of fire risks in temperature controlled structures of the refrigerated food industry*, The Cold Storage and Distribution Federation, 1996.

*Fire precautions in warehouses and distribution buildings*. The Fire Protection Association, 2002.

*LPC rules for automatic sprinkler installations*. The Fire Protection Association, 2003.

*Fire risk minimisation guidance*. Food Industry Panels Group, 2003.



# Index

Page numbers in italics refer to information in Figures or Tables.

## A

access for firefighters 23, 62–3, 64, 120, 121, 130  
 aerosols 46, 59, 61  
 alarms *see* fire detection and warning systems  
 alterations 8, 26, 49–50, 53, 58, 63, 134  
 alterations notices 7, 33, 35, 39, 50, 132  
 arson 13, 16, 18, 43, 44, 53  
 assembly points 38, 112, 114, 115, 117  
 automatic fire detection systems 20, 21, 56, 76, 77, 88, 102, 103, 132

## B

basements 78, 79, 94, 98–100, 132  
 building work 26, 49–50, 53

## C

cavity barriers 67, 123, 124  
 ceilings  
   fire-resisting 26, 67, 79  
   lining materials 14, 19, 123  
 children 6, 24, 35, 113, 132, 136  
 co-operation and co-ordination 6, 36, 115  
 competent persons 6, 10, 132  
 conduction, fire spreading by 16  
 construction, fire-resisting 26, 28, 49, 52–3, 67–8, 76, 77, 123–5  
 contingency plans 112, 113  
 contractors  
   certifying 31, 127  
   fire safety training 6, 115  
   managing 49–50  
   permit to work 18, 49  
   risk to 14, 15, 21, 36  
   source of ignition 12, 18, 49–50  
 convection, fire spreading by 16  
 cooking 12, 47–8, 50, 51, 52, 56, 115

## D

dangerous substances 6, 14, 113–14, 133  
   storage 18–19, 44–6, 53, 114  
 dead ends  
   escape routes 67, 72, 75–6, 77–8, 133  
   fire alarms 56  
 disability *see* people with special needs  
 display materials 13, 52  
 doors  
   door-fastening devices 128–9  
   door furniture 126–8  
   final exit 88  
   fire-resisting 52, 67, 78, 94, 112, 125–9, 133  
   glazing 126  
   maintenance 7, 17, 119, 120, 121, 127, 129  
   notices 107, 108  
   revolving 87  
   roller shutter doors 65, 87, 120

self-closing 79, 94, 108, 112, 121, 126–7, 135  
 sliding 87  
 vision panels 67, 126, 136  
 wicket 87

dust 46

## E

electrical safety 12–13, 15, 18, 45, 47  
 emergency escape lighting 28–9, 86, 104–5, 133  
   tests, checks and maintenance 30, 31, 32, 105–6, 110, 119, 120, 121  
 emergency plans 27, 33, 35, 36, 41, 110, 112–13, 115, 116, 130  
 equipment and machinery 12–13, 15, 18, 38, 39, 47–8  
 escape routes  
   age and construction of the premises 25–6, 28, 50, 67–8  
   alternative exits 74, 78, 88, 90, 132  
   basements 78, 79, 94, 98–100, 132  
   corridors 50, 67, 79, 80, 81, 94, 100, 102  
   dead ends 56, 67, 72, 75–6, 77–8, 133  
   emergency lighting 28–9, 86, 104–5, 133  
   escape time 25, 28, 70  
   final exits 26, 28, 82, 83, 88, 99, 110, 117, 133  
   inner rooms 73, 76, 134, 136  
   layouts 88–103  
   levels of risk 66, 68  
   lifts 25, 27, 38, 68, 86, 120, 133  
   lobbies 67, 78, 81, 94, 100, 102, 135  
   maintenance 85, 86  
   managing 27, 28, 68, 129  
   obstructions 27, 42, 50, 81, 88, 119  
   people with special needs 24, 27, 28  
   reception areas 84  
   roof exits 86, 87  
   signs and notices 29–30, 36, 107–9  
   suitability 67  
   tests and checks 30–2, 110, 119, 120, 121  
   training 27, 38  
   travel distance 20, 56, 66, 70, 71–2, 75–6, 88, 89, 95, 135  
   type and number of people using premises 25, 28  
   widths and capacity of 70  
   *see also* doors; stairways  
 extinguishers 22–3, 30, 31, 59–60

## F

factories  
   emergency escape lighting 28, 104  
   escape routes 28, 38, 43, 68, 104, 107  
   fire safety management 41  
   open-plan 104  
   sources of fuel 13–14, 43

- storage 43, 46
- false alarms 21, 56, 57, 110, 133
- fire
  - classes of 59, 60
  - spread of 16–17, 38, 50, 52
- fire blankets 60, 110
- fire certificates 5, 53
- fire dampers 47, 67
- fire detection and warning systems 21–2, 134
  - automatic fire detection systems 20, 21, 56, 76, 77, 88, 102, 103, 132
  - false alarms 21, 56, 57, 110, 133
  - manual call points 21, 55, 56, 57
  - monitoring 53, 56, 57
  - phased evacuation 21, 25, 57, 134
  - quality assurance 118
  - record-keeping 57, 110
  - smoke detectors 73, 78, 127, 135
  - sound levels 55
  - staged alarms 56–7, 135
  - tests and checks 7, 31, 32, 57, 110, 119, 120
  - voice alarms 21, 55, 120
- fire drills 37, 38, 110, 116–17
- fire marshals 23, 38, 116, 117, 131
- fire-resisting separation 53, 67, 123–5
- fire risk assessment
  - aims 9
  - co-operation and co-ordination 6, 36, 115
  - emergency plans 27, 33, 35, 41, 110, 112–13, 115, 116, 130
  - evaluating risk 15–17
  - Fire Safety Order and 5–8
  - flexibility 20, 41
  - historic buildings 130–1
  - identifying fire hazards 11, 12–14, 33, 122
  - identifying people at risk 11, 14–15, 33, 122
  - information and instruction 7, 35–7, 113–14
  - method 9–10, 11
  - plan of action 41
  - record-keeping 9, 11, 33–4, 110, 111, 112, 122
  - removing or reducing fire hazards 17–19, 33, 122
  - removing or reducing risk to people 4–5, 20–32, 33, 122
  - reviewing 11, 38–9, 122
  - sources of fuel 12, 13–14, 18–19, 42, 43, 44–6
  - sources of ignition 12–13, 15–16, 18, 45, 47–9, 50
  - sources of oxygen 12, 14, 19
- fire safety audit 110, 112
- fire safety management 4, 41, 49–50
- Fire Safety Order 5–8, 10
- fire stopping 53, 67, 124, 134
- fire suppression systems 19, 23, 42, 47, 52, 61–2, 63, 110, 116, 130
- firefighters' switches 30, 62, 64, 121
- firefighting equipment and facilities 22–4
  - access for firefighters 23, 62–3, 64, 120, 121, 130
  - extinguishers 22–3, 30, 31, 59–60
  - fire suppression systems 19, 23, 42, 47, 52, 61–2, 63, 110, 116, 130

- firefighters' switches 30, 62, 64, 121
- firefighting lifts and shafts 24, 27, 63, 68, 86, 96, 114, 120, 133
- foam inlets 23, 64
- hose reels 23, 31, 61, 110
- maintenance 7, 19, 23, 30, 31, 32, 61–2, 64, 65, 110, 119, 120, 121
- quality assurance 118
- rising mains 23, 64, 121
- signs 23, 108
- tests and checks 30, 31, 32, 60, 119, 120, 121
- training 7, 23, 38, 59, 116

fireworks 14

flame-retardant materials 52, 124–5

flammable liquids 13, 18–19, 45, 53, 59, 60, 114, 134

floors
 

- covering materials 14, 19
- fire-resisting 26, 53, 67, 86, 123, 124

foam inlets 23, 64

fork lift trucks 12, 18, 46, 47, 51

fuel, sources of 12, 13–14, 18–19, 42, 43, 44–6

function rooms 112

furniture and furnishings 13, 50

## G

- gas cylinders 14, 17, 19
  - see also* aerosols; LPG
- glass, fire-resisting 124, 126

## H

- hazard
  - definition 9
  - identifying fire hazards 11, 12–14, 33, 122
  - removing or reducing 17–19, 33, 122
- hazardous materials 21, 38, 39, 113, 114, 134
- heating 12, 18, 45, 47, 48, 51
- historic buildings 67, 130–1
- hose reels 23, 31, 61, 110
- housekeeping 38, 42

## I

- ignition, sources of 12–13, 15–16, 18, 45, 47–9, 50
- information and instruction 7, 35–7, 49, 107, 108–9, 113–14
- insulated core panels 42, 44, 51–2

## L

- ladders 67
- lifts
  - escape routes 25, 38, 68, 86, 120, 133
  - firefighting 24, 27, 63, 68, 86, 96, 114, 120, 133
- LPG 13, 15, 45, 47, 50
- luminaires 104, 105, 119, 120, 121









## M

- maintenance
  - checklist 119–21
  - emergency escape lighting 30, 31, 32, 105–6, 110, 119, 120, 121
  - equipment and machinery 47, 48

- escape routes 85, 86
  - fire detection and warning systems 7, 31, 32, 57, 61–2, 65, 110, 119–21
  - fire doors 7, 17, 119, 120, 121, 127, 129
  - firefighting equipment and facilities 7, 19, 23, 30, 31, 32, 61–2, 64, 65, 110, 119, 120, 121
  - mezzanine floors 50, 89, 91
  - multi-occupied buildings 4, 5
    - emergency plans 35, 36, 110
    - escape routes 67
    - fire detection and warning systems 21
    - fire risk assessment 15
    - information and instruction 107, 108
- O**
- oxygen, sources of 12, 14, 19
- P**
- partitions, fire-resisting 26, 50, 53, 123
    - see also* walls
  - people at risk
    - evaluating 16–17
    - identifying 11, 14–15, 33, 122
    - removing or reducing risk 4–5, 20–32, 33, 122
    - restricting the spread of fire and smoke 50, 52–3
    - type and number using premises 25, 39, 68
  - people with special needs 14
    - evacuating 24, 27, 28, 54, 57, 68–9, 116, 117
    - fire warning systems 55
    - information and instruction 36, 107
  - personal emergency evacuation plans (PEEPs) 25, 54
  - pipework 46
  - plans and specifications 33, 34, 112
  - portable appliance testing (PAT) 48
- R**
- radiation, fire spreading by 16
  - reception areas 84
  - record-keeping
    - emergency escape lighting 106, 110
    - fire detection and warning systems 57, 110
    - fire risk assessment 9, 11, 33–4, 110, 111, 112, 122
  - refuge areas 27, 68, 69, 112, 135
  - rising mains 23, 64, 121
  - risk
    - definition 9
    - evaluating 11, 15–17, 66
    - people at risk 11, 14, 16–17
    - reducing 4–5, 11, 20–32, 33, 43–6
  - roll calls 114, 117
  - roller shutter doors 65, 87, 120
  - roof exits 86, 87
- S**
- security 53
  - shafts, firefighting *see* lifts
  - signs and notices 23, 29–30, 107–9
    - information and instruction 36, 49
  - smoke
    - control of 52, 53, 56, 79, 102, 110, 121
    - dangers of 17
    - spread of 17, 38, 50, 52–3
  - Smoke and Heat Exhaust Ventilation Systems (SHEVS) 53, 56, 121
  - smoke detectors 73, 78, 127, 135
  - smoking 12, 15, 18, 49
  - sprinklers 19, 23, 42, 61–2, 63, 116, 120
  - staff
    - fire drills 37, 38, 110, 116–17
    - fire safety training 7, 20, 23, 27, 33, 35–6, 37–8, 59, 115–17
    - information and instruction 7, 35–7, 108–9, 113
    - see also* contractors
  - stairways
    - accommodation stairways 80, 84, 132
    - basements 78, 79, 94, 98–100
    - bypass routes 83, 84
    - external 85, 87, 133
    - hazards in 10, 50
    - protected 24, 80–3, 85, 88, 94, 95, 101, 135
    - spiral and helical 86
    - width and capacity of 70
  - storage 18–19, 42–6, 50, 53, 54, 114
    - outdoor 43
    - racking 13, 17, 25, 27, 42, 44, 72
- T**
- training
    - fire safety 6, 20, 27, 33, 35–6, 37–8, 115–17
    - firefighting equipment 7, 23, 38, 59, 116
- V**
- ventilation systems 14, 17, 19, 39, 53, 56, 121
  - vision panels 67, 73, 126, 136
  - voids 43, 50, 66, 67, 124, 130
- W**
- walls
    - fire-resisting 26, 47, 53, 67, 77, 123
    - insulated core panels 42, 44, 51–2
    - lining materials 14, 19, 123
    - see also* partitions
  - warehouses
    - emergency escape lighting 28, 104
    - escape routes 28, 38, 43, 68, 71, 92, 104, 107
    - fire safety management 41
    - open-plan 50, 104
    - sources of fuel 13–14, 43
    - storage 43, 46
  - waste and packaging, combustible 13, 15, 16, 19, 42, 43, 53
  - way guidance systems 29, 105, 136
  - windows, fire-resisting 85, 86, 124, 126
    - vision panels 67, 73, 126, 136

This guide is for employers, managers, occupiers and owners of factories and warehouses. It tells you what you have to do to comply with fire safety law, helps you to carry out a fire risk assessment and identify the general fire precautions you need to have in place.

Other guides in the series:

Guide	Main use
 <i>Offices and shops</i> ISBN-13: 978 1 85112 815 0	Offices and retail premises (including individual units within larger premises, e.g. shopping centres).
 <i>Factories and warehouses</i> ISBN-13: 978 1 85112 816 7	Factories and warehouse storage premises.
 <i>Sleeping accommodation</i> ISBN-13: 978 1 85112 817 4	All premises where the main use is to provide sleeping accommodation, e.g. hotels, guest houses, B&Bs, hostels, residential training centres, holiday accommodation and the common areas of flats, maisonettes, HMOs and sheltered housing (other than those providing care – see Residential care premises), but excluding hospitals, residential care premises, places of custody and single private dwellings
 <i>Residential care premises</i> ISBN-13: 978 1 85112 818 1	Residential care and nursing homes, common areas of sheltered housing (where care is provided) and similar premises, which are permanently staffed and where the primary use is the provision of care rather than healthcare (see Healthcare premises).
 <i>Educational premises</i> ISBN-13: 978 1 85112 819 8	Teaching establishments ranging from pre-school through to universities, except the residential parts (see Sleeping accommodation).
 <i>Small and medium places of assembly</i> ISBN-13: 978 1 85112 820 4	Smaller public houses, clubs, restaurants and cafés, village halls, community centres, libraries, marquees, churches and other places of worship or study accommodating up to 300 people.
 <i>Large places of assembly</i> ISBN-13: 978 1 85112 821 1	Larger premises where more than 300 people could gather, e.g. shopping centres (not the individual shops), large nightclubs and pubs, exhibition and conference centres, sports stadia, marquees, museums, libraries, churches, cathedrals and other places of worship or study.
 <i>Theatres, cinemas and similar premises</i> ISBN-13: 978 1 85112 822 8	Theatres, cinemas, concert halls and similar premises used primarily for this purpose.
 <i>Open air events and venues</i> ISBN-13: 978 1 85112 823 5	Open air events, e.g. theme parks, zoos, music concerts, sporting events (not stadia – see Large places of assembly), fairgrounds and county fairs.
 <i>Healthcare premises</i> ISBN-13: 978 1 85112 824 2	Premises where the primary use is the provision of healthcare (including private), e.g. hospitals, doctors' surgeries, dentists and other similar healthcare premises.
 <i>Transport premises and facilities</i> ISBN-13: 978 1 85112 825 9	Transportation terminals and interchanges, e.g. airports, railway stations (including sub-surface), transport tunnels, ports, bus and coach stations and similar premises but excluding the the means of transport (e.g. trains, buses, planes and ships).

ISBN-13: 978 1 85112 816 7

ISBN-10: 1 85112 816 6

Price: £12

ISBN 978185112816-7



9 781851 128167 >